

Appendix III

Traffic Impact Assessment

**Concrete Batching Plant at Tsing Yi
- Renewal Application A/TY/139**

Traffic Impact Assessment

Final Report

(May 2024)



CTA Consultants Limited
志達顧問有限公司



LIST OF CONTENT

1.	INTRODUCTION.....	1
1.1	Background	1
1.2	Study Objectives	1
1.3	Structure of this Report	1
2.	THE DEVELOPMENT	3
2.1	Site Location	3
2.2	Development Proposal	3
2.3	Traffic Arrangement.....	3
3.	THE EXISTING TRAFFIC CONDITION.....	4
3.1	Existing Road Network	4
3.2	Critical Junctions.....	4
3.3	Public Transport Services in the Vicinity	7
4.	THE FUTURE TRAFFIC CONDITIONS	8
4.1	Design Year.....	8
4.2	Design Traffic Flows.....	8
4.3	Planned / Committed Future Developments	9
4.4	Development Traffic Flows	12
5.	TRAFFIC IMPACT ASSESSMENT	13
5.1	Traffic Generation Calculation.....	13
5.2	Operational Assessment	13
5.3	Traffic Management Plan.....	15
6.	SUMMARY AND CONCLUSION.....	16
6.1	Summary	16
6.2	Conclusion.....	17



1. INTRODUCTION

1.1 Background

1.1.1 The concrete batching plant of the captioned Planning Approval is located at Sai Tso Wan Road, Tsing Yi and shown in **Figure 1.1**.

1.1.2 The captioned Planning Approval (Planning Application No. A/TY/139) was granted in 2019 and will expire on 6 September 2024. The Applicant would like to submit a renewal planning application for another 5 years.

1.1.3 We, CTA Consultants Limited (CTA), is commissioned as the traffic consultant to undertake a Traffic Impact Assessment (TIA) study for assessing the traffic impact, and to propose any measures if necessary.

1.2 Study Objectives

1.2.1 The main objectives of this study are as follows:

- to carry out a traffic impact assessment to identify the acceptability of the concrete batching plant in traffic terms;
- to assess the existing traffic conditions in the vicinity of the plant;
- to forecast traffic demands in the adjacent road network in the design year 2029;
- to assess the impacts of traffic generated by the adjacent new developments in the road network; and
- to propose any traffic improvement measures for alleviating any foreseeable traffic problems if necessary.

1.3 Structure of this Report

1.2.2 Following this introductory chapter, there are five further chapters.

- **Chapter 2 – THE DEVELOPMENT**, which presents the site location and production information of the plant.
- **Chapter 3 – THE EXISTING TRAFFIC CONDITION**, which describes the



existing local road network, in the vicinity of Study Area, presents a summary of the traffic count survey and assesses the existing traffic conditions.

- **Chapter 4 – THE FUTURE TRAFFIC CONDITION**, which estimates the future traffic flows on the surrounding road network.
- **Chapter 5 – TRAFFIC IMPACT ASSESSMENT**, which discusses the methodology for the future traffic forecasts.
- **Chapter 6 – SUMMARY AND CONCLUSION**, which summarizes the findings of the study and presents the conclusions regarding the traffic issues associated with the plant.



2. THE DEVELOPMENT

2.1 Site Location

2.1.1 The plant is situated along Sai Tso Wan Road via Tsing Yi Road West. As shown in **Figure 1.1**, the development is located at the western seaside of Tsing Yi, which can only be accessed by Sai Tso Wan Road.

2.1.2 The layout of the existing plant is shown in **Figure 2.1**. An existing concrete batching plant (A/TY/143) and an asphalt plant (A/TY/144) are adjacent to the Application Site.

2.2 Development Proposal

2.2.1 The concrete batching plant is scheduled to extend its license from 2024 to another 5 years to 2029.

2.2.2 There is no material change in operational parameters since the previous temporary approval (A/TY/139) granted in 2019. The daily production capacity is 3,000 m³ concrete. Its normal operation will last for 12 hours every day, from Mondays to Saturdays and occasionally on Sundays and public holidays. The hourly maximum production capacity of the concrete batching plant is 250 m³/hr.

2.3 Traffic Arrangement

2.3.1 To facilitate the operation of the plant, the following types of parking facilities are provided within the plant:

- 5 nos. of private car parking space;
- 4 nos. of Loading/ Unloading Spaces (including 3 under the production bays) ;
and
- 29 nos. of waiting/parking spaces at marshalling area



3. THE EXISTING TRAFFIC CONDITION

3.1 Existing Road Network

3.1.1 The plant will be accessed through Tsing Yi Road West, Tsing Yi Road and Sai Tso Wan Road.

3.1.2 Sai Tso Wan Road is a 2-lane local road connecting Sai Tso Wan area and Tsing Yi Road West/Tsing Yi Road. It is a major road link providing access to/from various sites in Sai Tso Wan area.

3.2 Critical Junctions

3.2.1 In order to establish the existing traffic condition in the vicinity, traffic survey in form of manual classification counts was conducted at 20 critical junctions. The location of the surveyed junctions is indicated in **Figure 3.1** and their existing junction layout arrangements are given in **Figures 3.2 to 3.21** respectively.

Table 3.1 Identified Critical Junctions

Ref.	Junction	Type	Figure No.
J1	Cheung Tsing Highway / Tsing Yi Road West	Signalized	3.2
J2	Tsing Hung Road / Tsing Yi Road	Signalized	3.3
J3	Tsing Sheung Road / Tsing Yi Road Priority	Priority	3.4
J4	Sai Tso Wan Road / Tsing Yi Road / Tsing Yi Road West	Signalized	3.5
J5	Car Park Entrance / Sai Tso Wan Road	Signalized	3.6
J6	Tsing Tim Street / Sai Tso Wan Road	Priority	3.7
J7	Tsing Yi Road West / Tsing Chin Street*	Priority	3.8
J8	Tsing Yi Road West / Tsing Hong Road	Signalized	3.9
J9	Tsing Yi Road West / Liu To Road	Signalized	3.10
J10	Tsing Yi Road West / Fung Shue Wo Road	Signalized	3.11
RA1	Tsing Yi Interchange	Roundabout	3.12
RA2	Tsing Yi Road West / Tsing Yi Hong Wan Road / Tsing Sha Highway	Roundabout	3.13
RA3	Hong Wan Road	Roundabout	3.14
RA4	Hong Wan Road / Tsing Ko Road	Roundabout	3.15
RA5	Tam Kon Shan Interchange	Roundabout	3.16
RA6	Tsing Yi Heung Sze Wui Road / Fung Shue Wo Road / Tsing King Road	Roundabout	3.17
RA7	Tsing Sheung Road / Tsing Yi Hong Wan Road	Roundabout	3.18
RA8	Tsing Hong Road / Tsing Yi Road	Roundabout	3.19
RA9	Tam Kon Shan Road / Tsing Yi North Costal Road	Roundabout	3.20
RA10	Tsing Ko Road / Tsing Sheung Road	Roundabout	3.21

3.2.2 The survey was conducted during the morning, logistic peak and evening peak periods in 26 January 2024. The survey provides details of the traffic situation in the nearby area. Based on surveyed traffic flows, it was found that the AM, logistic and PM peak hour occurred from 08:00 to 09:00, 11:15 to 12:15 and 17:30 to 18:30 respectively. The results of the observed traffic flows are presented in **Figure 3.22**.

3.2.3 Based on the observed traffic flows in **Figure 3.22**, the junction capacity assessment is carried out for the critical junctions and the results of the assessment are summarized in **Table 3.2** below.



Table 3.2 Operational Performance of Identified Critical Junctions in 2024

Ref.	Junction	Method of Control	Year 2024 Observed Case		
			RC/RFC ⁽¹⁾		
			AM Peak	Logistic Peak	PM Peak
J1	Cheung Tsing Highway / Tsing Yi Road West	Signalized	89%	75%	>100%
J2	Tsing Hung Road / Tsing Yi Road	Signalized	>100%	>100%	>100%
J3	Tsing Sheung Road / Tsing Yi Road Priority	Priority	0.49	0.41	0.41
J4	Sai Tso Wan Road / Tsing Yi Road / Tsing Yi Road West	Signalized	62%	41%	>100%
J5	Car Park Entrance / Sai Tso Wan Road	Signalized	86%	53%	>100%
J6	Tsing Tim Street / Sai Tso Wan Road	Priority	0.31	0.25	0.21
J7	Tsing Yi Road West / Tsing Chin Street*	Priority	N/A	N/A	N/A
J8	Tsing Yi Road West / Tsing Hong Road	Signalized	68%	93%	>100%
J9	Tsing Yi Road West / Liu To Road	Signalized	39%	65%	56%
J10	Tsing Yi Road West / Fung Shue Wo Road	Signalized	>100%	>100%	>100%
RA1	Tsing Yi Interchange (North)	Roundabout	0.71	0.59	0.41
	Tsing Yi Interchange (South)	Roundabout	0.58	0.44	0.66
RA2	Tsing Yi Road West / Tsing Yi Hong Wan Road / Tsing Sha Highway	Roundabout	0.71	0.60	0.48
RA3	Hong Wan Road	Roundabout	0.33	0.28	0.40
RA4	Hong Wan Road / Tsing Ko Road	Roundabout	0.25	0.24	0.26
RA5	Tam Kon Shan Interchange	Roundabout	0.65	0.59	0.67
RA6	Tsing Yi Heung Sze Wui Road / Fung Shue Wo Road / Tsing King Road	Roundabout	0.38	0.32	0.38
RA7	Tsing Sheung Road / Tsing Yi Hong Wan Road	Roundabout	0.07	0.08	0.10
RA8	Tsing Hong Road / Tsing Yi Road	Roundabout	0.44	0.37	0.36
RA9	Tam Kon Shan Road / Tsing Yi North Costal Road	Roundabout	0.06	0.08	0.08
RA10	Tsing Ko Road / Tsing Sheung Road	Roundabout	0.13	0.12	0.09

Note: (1) RC = Reserve Capacity RFC = Ratio of Flow to Capacity for Priority Junction

3.2.4 The results in **Table 3.2** show that the junctions are now operating with ample capacities in peak hours.



3.3 Public Transport Services in the Vicinity

3.3.1 Limited road-based public transport services are currently operating in the vicinity of the plant. Only one GMB route is operating close to the plant (within 500m radius from the plant) and the details of the GMB route are presented in **Table 3.3** below.

Table 3.3 Existing Road-based Public Transport Services in the Vicinity

Service	Route	Origin - Destination	Frequency (min)
GMB	88M	Kwai Fong Station – Sai Tso Wan Road (Hong Kong Unit Dockyard)	6 – 15



4. THE FUTURE TRAFFIC CONDITIONS

4.1 Design Year

4.1.1 The original planning approval will expire on 6 September 2024, as another 5 year of temporary use is applied, year 2029 is adopted as the design year for this study to assess the impact of the development related traffic on the local road network.

4.2 Design Traffic Flows

4.2.1 To estimate the 2029 traffic flows in the local road network, an appropriate growth factor has to be identified for the area in the first instance based on historical trend and planning data.

Historical Trend

4.2.2 Transport Department has traffic count stations in the vicinity of the development. The traffic counts reported in the Annual Traffic Census (ATC) over a period of 6 years, between 2017 and 2022 are summarized in **Table 4.1**.

Table 4.1 Historical Traffic Data from Annual Traffic Census

ATC Stn No.	Road Name	Annual Average Daily Traffic						Annual Growth Rate
		2017	2018	2019	2020	2021	2022	
5038	Nam Wan Tunnel (from East Tsing Yi Viaduct to Cheung Tsing Highway)	50,940	54,280	55,040	37,850	41,090	41,060	-4.22%
5849	Tsing Yi Rd W (Tsing Nam St – Ching Hong Road)	15,410	15,640*	15,580*	15,430*	13,690	15,820	0.53%
6044	Tsing Yi Rd W (Tsing Hong Road – Fung Shue Wo Road)	20,260	19,350	19,280*	19,100*	19,840*	21,050	0.77%
6643	Sai Tso Wan Rd (Tsing Yi Rd – Dockyard Front Gate)	5,020	10,030	8,390	8,960	9,410	11,200	17.41%
TOTAL		91,630	99,300	98,290	81,340	84,030	89,130	-0.55%

*AADT estimated by Growth Factor

4.2.3 As shown in **Table 4.1**, the average annual traffic growth pattern in the vicinity of the development shows a growth trend of -0.55% per year.

2019-Based TPEDM planning data

4.2.4 Reference has also been made to the latest 2019-Based Territorial Population Employment Data Matrices (TPEDM) planning data published by the Planning Department for projection of population and employment within the study district. The average annual growth rates in terms of population and employment from 2019 to 2031 are tabulated in **Table 4.2**.

Table 4.2 2019-based Population and Employment Growth

Tsing Yi				
Data	Year			Average Annual Growth Rate
	2019	2026	2031	
Population	182,350	188,550	184,400	+0.09%
Employment	38,500	38,700	36,650	-0.41%
Total	220,850	227,250	221,050	0.01%

4.2.5 From **Table 4.2**, it is found that the average annual growth rates of population and employment in Tsing Yi are +0.01% per annum respectively.

Adopted Growth Rate

4.2.6 A.A.D.T. of ATC indicates that the traffic flow of the local road network has an average annual growth rate of -0.55%.

4.2.7 Whilst, the planning data indicates that the population and employment of the study area are expected to grow with an average annual growth rate of +0.01%.

4.2.8 As a conservative approach, annual growth rate **+1.0%** p.a. has been adopted for projecting traffic forecasts. It is deemed sufficient to allow for any unexpected future growth as a result of some changes in land use or development in the study area.

4.3 Planned / Committed Future Developments

4.3.1 There are numbers of planned/committed future developments in vicinity. The updated planning parameters are shown in **Table 4.3**. The locations of these future developments are shown in **Figure 4.1**.

4.3.2 The traffic trips generated from these planned/committed developments are estimated and shown in **Table 4.4**.

4.3.3 These traffic trips were assigned to the road network to obtain the reference traffic in the design year.

Table 4.3 Development Schedule of Planned Development at Vicinity

Ref.	Development Site / Planning Application No.	Use	Development Parameters	Completion Year
A	A/TY/131	Animal Welfare Centre	About 8,720m ²	2024
B	Ching Hong Road North Public Housing Development	Public Housing	Phase 1: 851 units	2024
			Phase 2: 612 units	2024
			Phase 3: 1680 units	2029
			Retail: 2000m ² Social Welfare Facilities	2024 - 2029
C	Agreement No. WQ/216/22	No details in public domain		
D	Proposed Advanced Construction Industry Building (ACIB) development in Tsing Yi	The project is under preliminary study stage and project details is not observed in public domain		
E	Housing Development at Tsing Yi Road West	Public Housing	3,400 units	2034/35
F ⁽¹⁾	Y/TY/2 - Tsing Yi Town Lot 80 and 108RP (Phase 1)	Private Housing	5,048 units	2028
	Y/TY/2 - Tsing Yi Town Lot 80 and 108RP (Phase 2)	Public Housing	4,704 units	2036
		Private Housing	5,323 units	2036
G	Government Dangerous Goods Warehouse and a government Owned Rental Dangerous Goods Warehouse to FSD	Warehouse	No details in public domain	
H	Multi-Storey Complex at Tsing Hung Road (CE 14/2016)	Container Storage and Cargo Handling	Site area: About 6 a	No target completion year
I	Land Exchange at Tsing Yi Hong Wan Road	No details in public domain		
J	Renewal of A/TY/135	Asphalt Plant	260 tonnes/hr (208 tones/hr as limited by SP License)	2024

Note: (1) This application site will be redeveloped to part of Y/TY/2, if approved.

4.3.4 Some of the planned developments in **Table 4.3** could not found in public domain, or no target completion year. As the location of this application is part of Y/TY/2 - Tsing Yi Town Lot 80 and 108RP, this concrete plant will be closed down and redeveloped to Y/TY/2 if approved. Thus, they would not be included in this assessment. The anticipated commissioning date of Route 11 (section between Yuen Long and North Lantau) is 2033, but no programme on TYLL section yet. The construction scale, methodology and works programme, etc., of Route 11 are unknown by the public, it is unlikely for us to estimate their construction traffic and it is the duty of the project proponents to conduct CTIAs to access the traffic condition and provide mitigation measures, such as TTA, road widening, junction improvement, peak hour banning, etc., to ensure their trips will not affect the traffic network.

Table 4.4 Estimated Traffic Generations of Planned Vicinity Development

Development Type	Average Flat Size m ²	Unit	Trip Rate			
			AM Peak		PM Peak	
			Gen.	Att.	Gen.	Att.
Public Rental	40	Pcu/hr/flat	0.0432	0.0326	0.0237	0.0301
Retail	-	pcu/hr/100 sqm GFA	0.2296	0.2434	0.3100	0.3563
Developments			Trips (Pcu/hr)			
A ⁽¹⁾	A/TY/131		64	172	115	72
B	Ching Hong Road North Public Housing Development	Phase 1	37	28	20	26
		Phase 2	26	20	15	18
		Phase 3	73	55	40	51
		Retail	5	5	6	7
		Kindergarten ⁽²⁾	30	30	30	30
		Social Welfare Facilities ⁽³⁾	10	10	10	10
C ⁽¹⁾	Renewal of A/TY/135		45	45	45	45

Note: (1) Development trips according to its TIA report

(2) Reference from other public housing TIA reports (Sheung Shui Area 4 and 30)

(3) Nominal Trips

4.3.5 The 2029 reference flows are then derived by applying the annual growth rate plus the additional traffic generations of the developments in Tsing Yi.

$$\begin{array}{rcccl} \mathbf{2029} & & & & \\ \mathbf{Reference\ Flows} & = & \mathbf{2024} & \mathbf{Adopted\ Growth} & \mathbf{Traffic\ Flows\ of} \\ \mathbf{(without\ the} & & \mathbf{Observed} & \mathbf{Factor} & \mathbf{Proposed} \\ \mathbf{Plant)} & & \mathbf{Flows} & \mathbf{(i.e.\ +1\% \ p.a.\ for} & \mathbf{Developments\ at} \\ & & & \mathbf{5\ years)} & \mathbf{Tsing\ Yi} \\ & & & & \mathbf{+} \end{array}$$

4.4 Development Traffic Flows

4.4.1 It is revealed that this is a renewal application, the concrete batching plant is already under operation and the development parameter is no change. Therefore, there will be **no additional traffic trip**. The 2029 design flows are shown in **Figure 4.2**.

$$\mathbf{2029\ Design\ Flows = 2029\ Reference\ Flows}$$

5. TRAFFIC IMPACT ASSESSMENT

5.1 Traffic Generation Calculation

5.1.1 As there is no change in the operation scale of the plant, no additional trips are generated. The traffic generation adopted in the approved TIA for the exiting plant (A/TY/139) is summarized in **Table 5.1** below for reference:

Table 5.1 Adopted Hourly Traffic Generation of the Concrete Batching Plant

Types of Vehicles	Traffic Generation (in veh/hr)	Traffic Generation (in pcu/hr) ⁽¹⁾
Pulverized Fuel Ash (PFA) Tanker	0.25	1
Ice Truck	0.83	2
Waste Removal Truck	0.17	1
Admixture Truck	0.17	1
Concrete Mixer Truck	18	45
Private Car & Van	0.83	1
Total		51

Notes: (1) PCU factor of 2.5 has been adopted for trucks.

(2) Assuming the concrete average carrying capacity of each concrete mixer truck is 7.4m³.

5.2 Operational Assessment

5.2.1 Based on the design traffic flows in **Figure 5.1**, a junction capacity assessment is carried out for the key junctions and the results of the assessment are summarized in **Table 5.2** below.



Table 5.2 Junction Performance of Critical Junctions in Design Year 2029

Ref.	Junction	Method of Control	Year 2029 Design Case		
			RC/RFC ⁽¹⁾		
			AM Peak	Logistic Peak	PM Peak
J1	Cheung Tsing Highway / Tsing Yi Road West	Signalized	72%	60%	120%
J2	Tsing Hung Road / Tsing Yi Road	Signalized	91%	98%	108%
J3	Tsing Sheung Road / Tsing Yi Road Priority	Priority	0.53	0.44	0.44
J4	Sai Tso Wan Road / Tsing Yi Road / Tsing Yi Road West	Signalized	46%	27%	116%
J5	Car Park Entrance / Sai Tso Wan Road	Signalized	67%	39%	134%
J6	Tsing Tim Street / Sai Tso Wan Road	Priority	0.35	0.28	0.24
J7	Tsing Yi Road West / Tsing Chin Street*	Priority	N/A	N/A	N/A
J8	Tsing Yi Road West / Tsing Hong Road	Signalized	42%	60%	82%
J9	Tsing Yi Road West / Liu To Road	Signalized	31%	56%	47%
J10	Tsing Yi Road West / Fung Shue Wo Road	Signalized	84%	113%	132%
RA1	Tsing Yi Interchange (North)	Roundabout	0.77	0.64	0.45
	Tsing Yi Interchange (South)	Roundabout	0.64	0.48	0.74
RA2	Tsing Yi Road West / Tsing Yi Hong Wan Road / Tsing Sha Highway	Roundabout	0.75	0.64	0.52
RA3	Hong Wan Road	Roundabout	0.35	0.29	0.42
RA4	Hong Wan Road / Tsing Ko Road	Roundabout	0.26	0.25	0.27
RA5	Tam Kon Shan Interchange	Roundabout	0.74	0.67	0.78
RA6	Tsing Yi Heung Sze Wui Road / Fung Shue Wo Road / Tsing King Road	Roundabout	0.48	0.41	0.46
RA7	Tsing Sheung Road / Tsing Yi Hong Wan Road	Roundabout	0.07	0.08	0.10
RA8	Tsing Hong Road / Tsing Yi Road	Roundabout	0.48	0.41	0.40
RA9	Tam Kon Shan Road / Tsing Yi North Costal Road	Roundabout	0.07	0.08	0.08
RA10	Tsing Ko Road / Tsing Sheung Road	Roundabout	0.13	0.13	0.10

Note: (1) RC = Reserve Capacity RFC = Ratio of Flow to Capacity for Priority Junction
(2) Only ingress traffic is allowed on Tsing Chin Street. No traffic conflicts or delay is expected in this location. Therefore, no junction assessment is required.



5.2.2 Based on the assessment presented in **Table 5.2**, all junctions will be operating with ample capacities during design year. As the concrete batching plant is already under operation and the development parameter is no change under this renewal application, there will be no additional traffic impact caused by the plant.

5.3 Traffic Management Plan

5.3.1 Detailed Traffic Management Plan will be formulated and submitted to Transport Department separately.



6. SUMMARY AND CONCLUSION

6.1 Summary

- 6.1.1 The captioned Planning Approval (Approved Planning Application no.: A/TY/139) was granted in 2019 and will expire on 6 September 2024. The Applicant would like to submit a renewal planning application for another 5 years.
- 6.1.2 We, CTA Consultants Limited (CTA), is commissioned as the traffic consultant to undertake a Traffic Impact Assessment (TIA) study for assessing the traffic impact, and to propose any measures if necessary.
- 6.1.3 To appraise the existing traffic conditions, a traffic count survey was conducted in the surrounding road network of the plant. Moreover, current operational performance of the critical junctions was assessed with the observed traffic flows. The operational assessment results revealed that all critical junctions are at present operating with reasonable capacity in peak hours.
- 6.1.4 In order to assess the impact of the development related traffic on the local road network, the 5th year after the approval of extension application of the plant (i.e. year 2029) has been adopted as the design year for this study.
- 6.1.5 To reveal the traffic impact of various proposed developments in the vicinity, traffic generations by the proposed developments in the vicinity have also been taken into consideration.
- 6.1.6 It is noted that the concrete plant is already operating currently, thus **no additional traffic** would be added to the road network by this plant under this application and 2029 design flows are the same as reference flows. It is noted that growth rate is also applied to the existing trips of the application plant as conservative approach.
- 6.1.7 All the assessed junctions will be operating with ample spare capacity in design year.



6.2 Conclusion

- 6.2.1 In conclusion, this Traffic Impact Assessment (TIA) has demonstrated that the application plant will not generate additional traffic to the surrounding road network and the junctions in vicinity would have ample capacities during design year 2029.
- 6.2.2 Hence, it is concluded that the renewal of the plant at the Application Site is acceptable from traffic engineering view point.

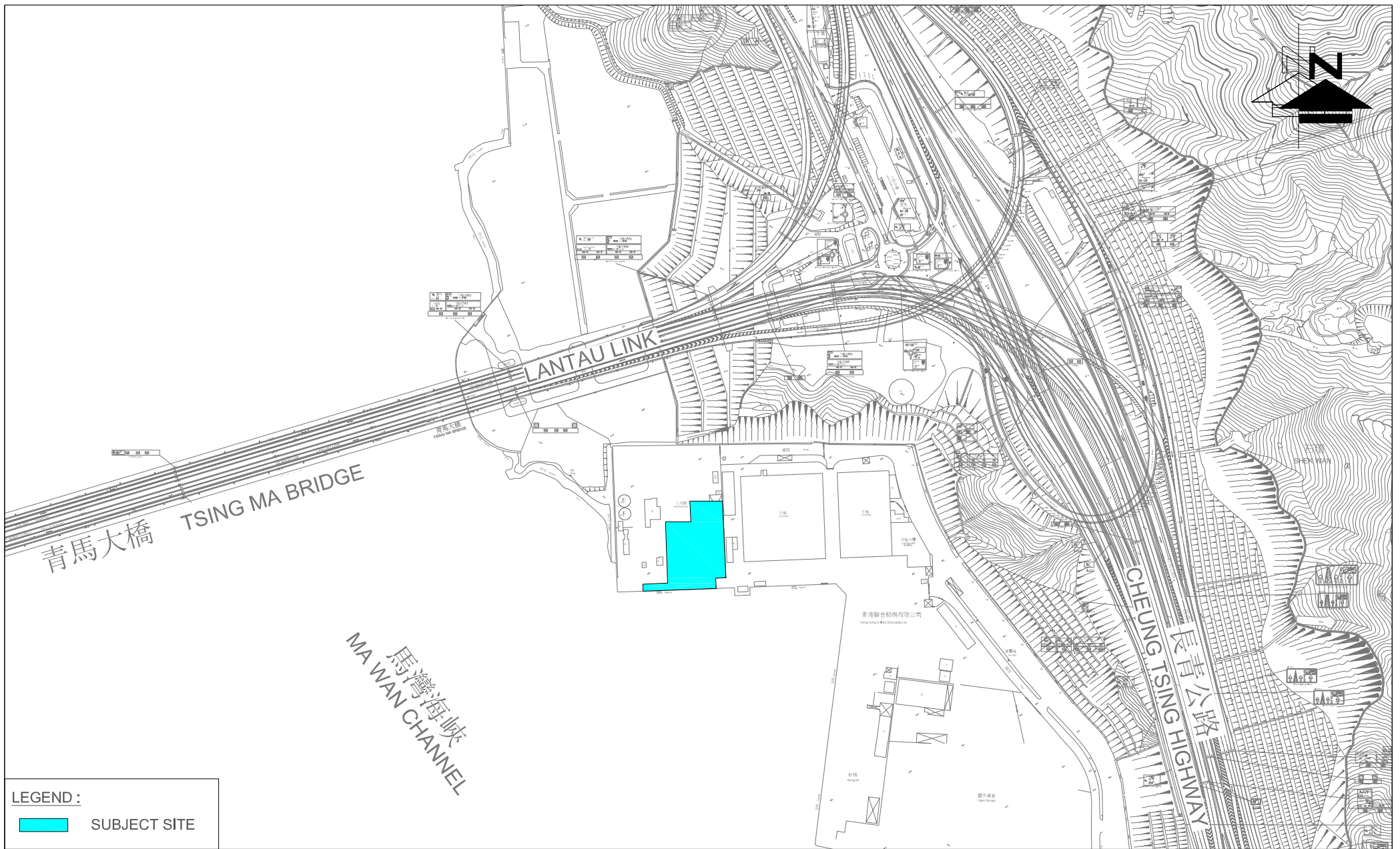

LEGEND :
 SUBJECT SITE

FIGURE NO.:		PROJECT TITLE:	
1.1		Concrete Batching Plant at Tsing Yi - Renewal Application A/TY/139	
PROJECT NO.:		DRAWING TITLE:	
24002HK		SITE LOCATION PLAN	
SCALE:	DATE:		
1 : 5000 @A4	01 FEB 2024		



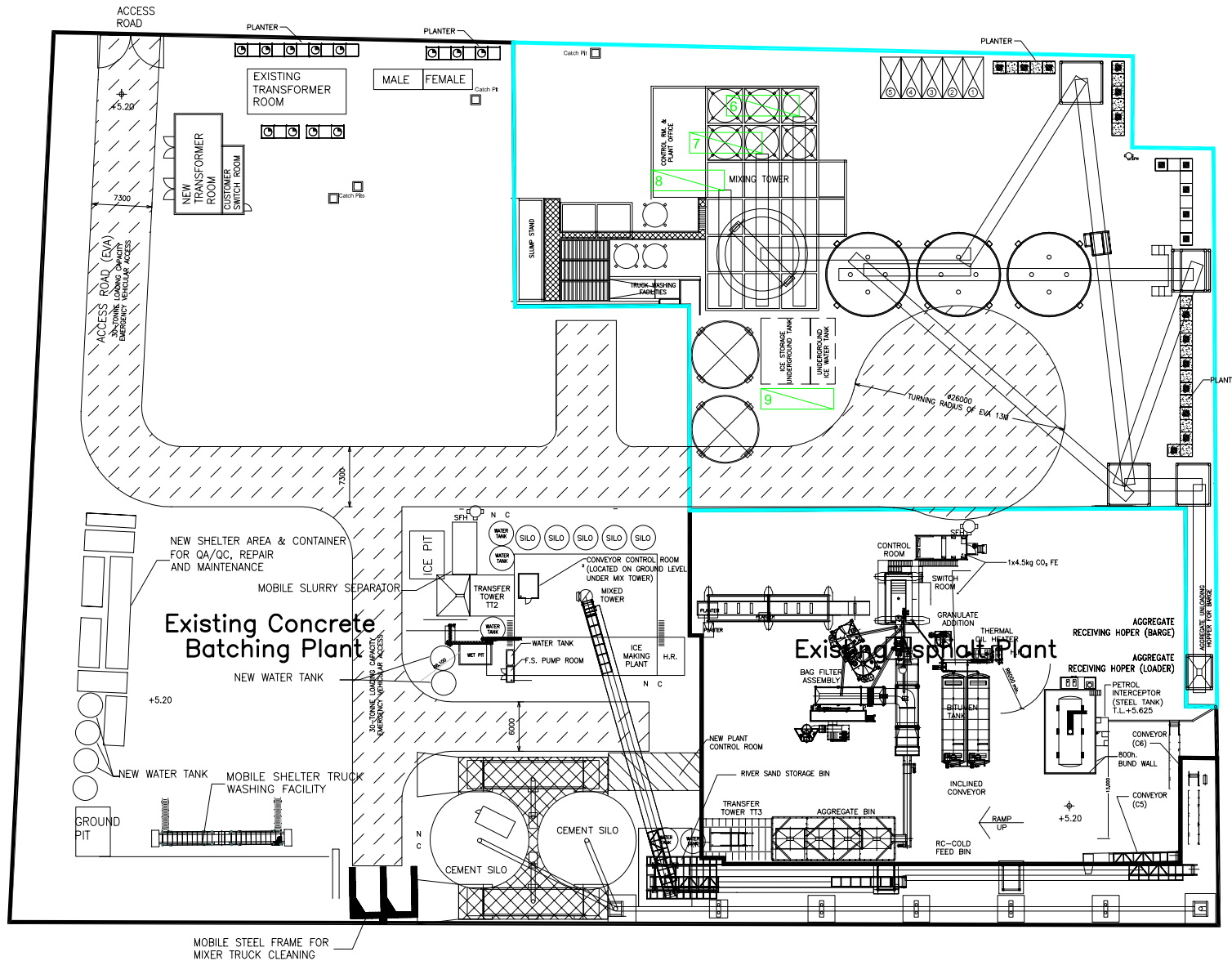
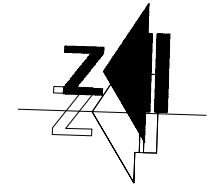

LEGEND :

	SUBJECT SITE BOUNDARY OF PROPOSED CONCRETE BATCHING PLANT
	INTERNAL ACCESS ROAD
	PARKING SPACE
	LOADING / UNLOADING SPACE

FIGURE NO.:		PROJECT TITLE:	
2.1		Concrete Batching Plant at Tsing Yi - Renewal Application A/TY/139	
PROJECT NO.:		DRAWING TITLE:	
24002HK		LAYOUT PLAN FOR EXISTING CONCRETE BATCHING PLANT	
SCALE:	DATE:		
1 : 750 @A4	01 FEB 2024		



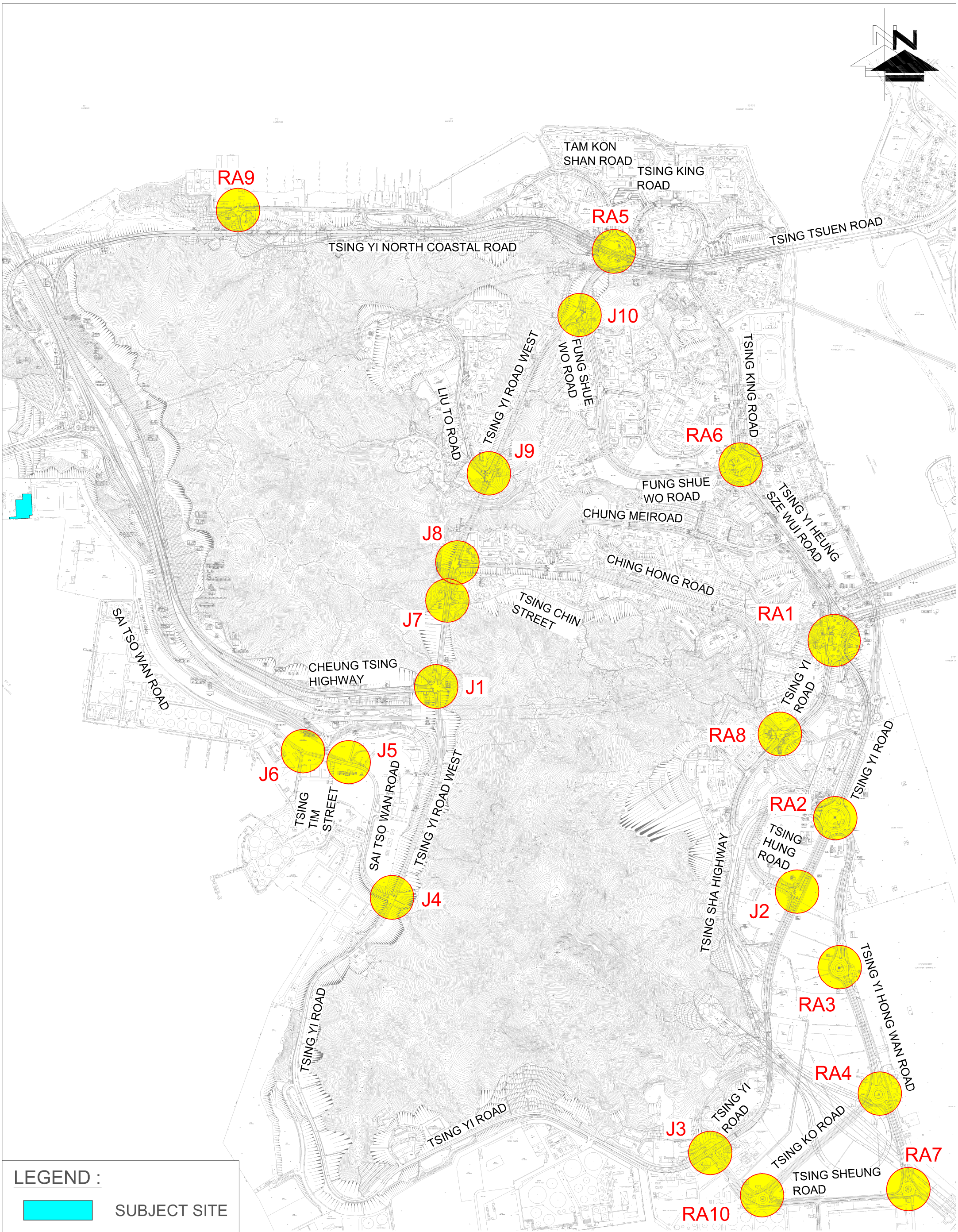
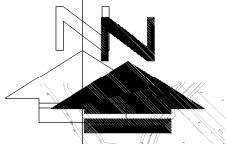

LEGEND :



SUBJECT SITE

FIGURE NO.:	3.1
PROJECT NO.:	24002HK
SCALE:	DATE:
1 : 12000 @A3	02 MAY 2024

PROJECT TITLE:	Concrete Batching Plant at Tsing Yi - Renewal Application A/TY/139
DRAWING TITLE:	CRITICAL JUNCTION



CTA Consultants Limited
志達顧問有限公司

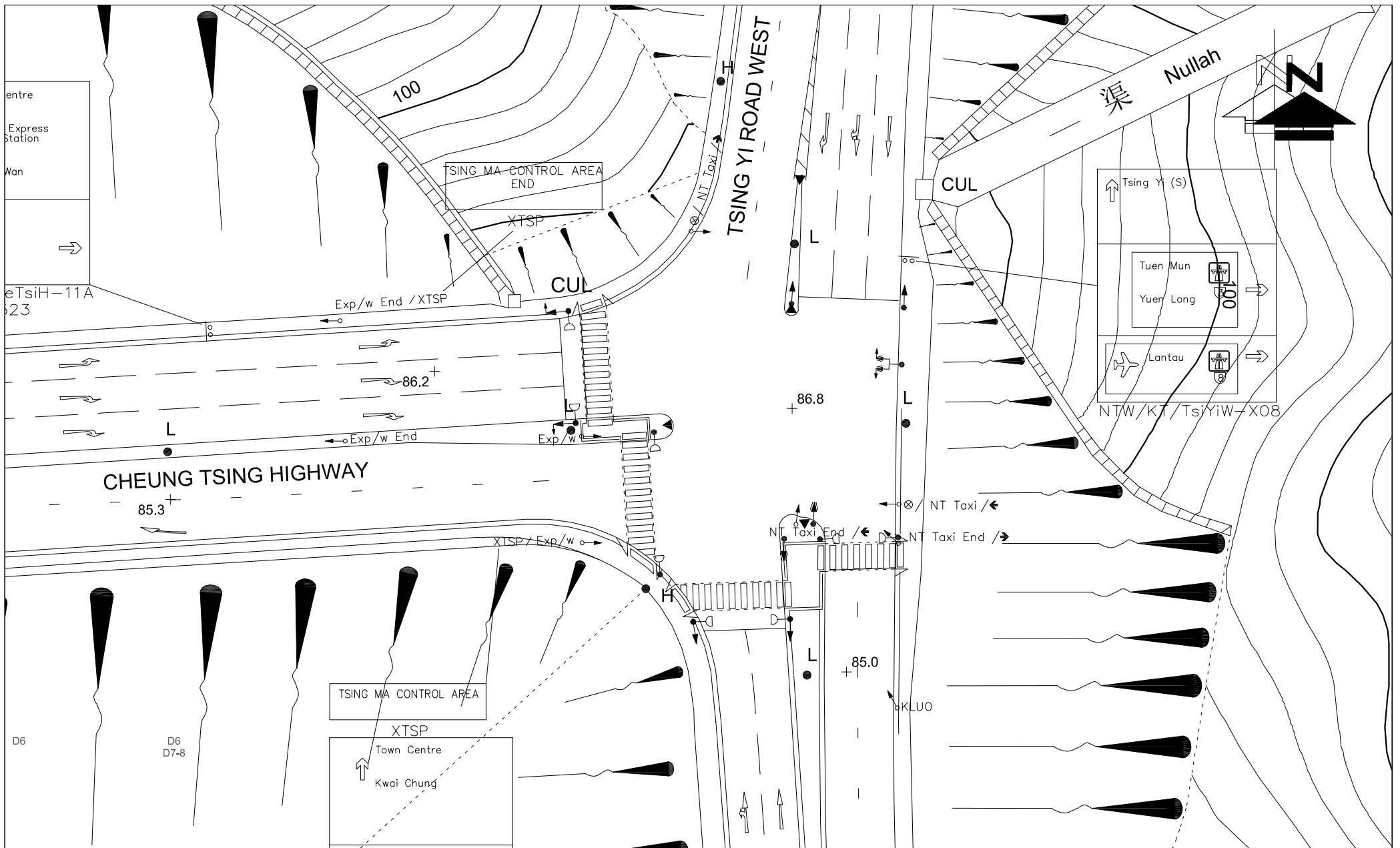



FIGURE NO.: 3.2		PROJECT TITLE: Concrete Batching Plant at Tsing Yi - Renewal Application A/TY/139	 CTA Consultants Limited 志達顧問有限公司
PROJECT NO.: 24002HK		DRAWING TITLE: EXISTING JUNCTION LAYOUT OF TSING YI ROAD WEST / CHEUNG TSING HIGHWAY (J1)	
SCALE: 1 : 500 @A4	DATE: 02 MAY 2024		

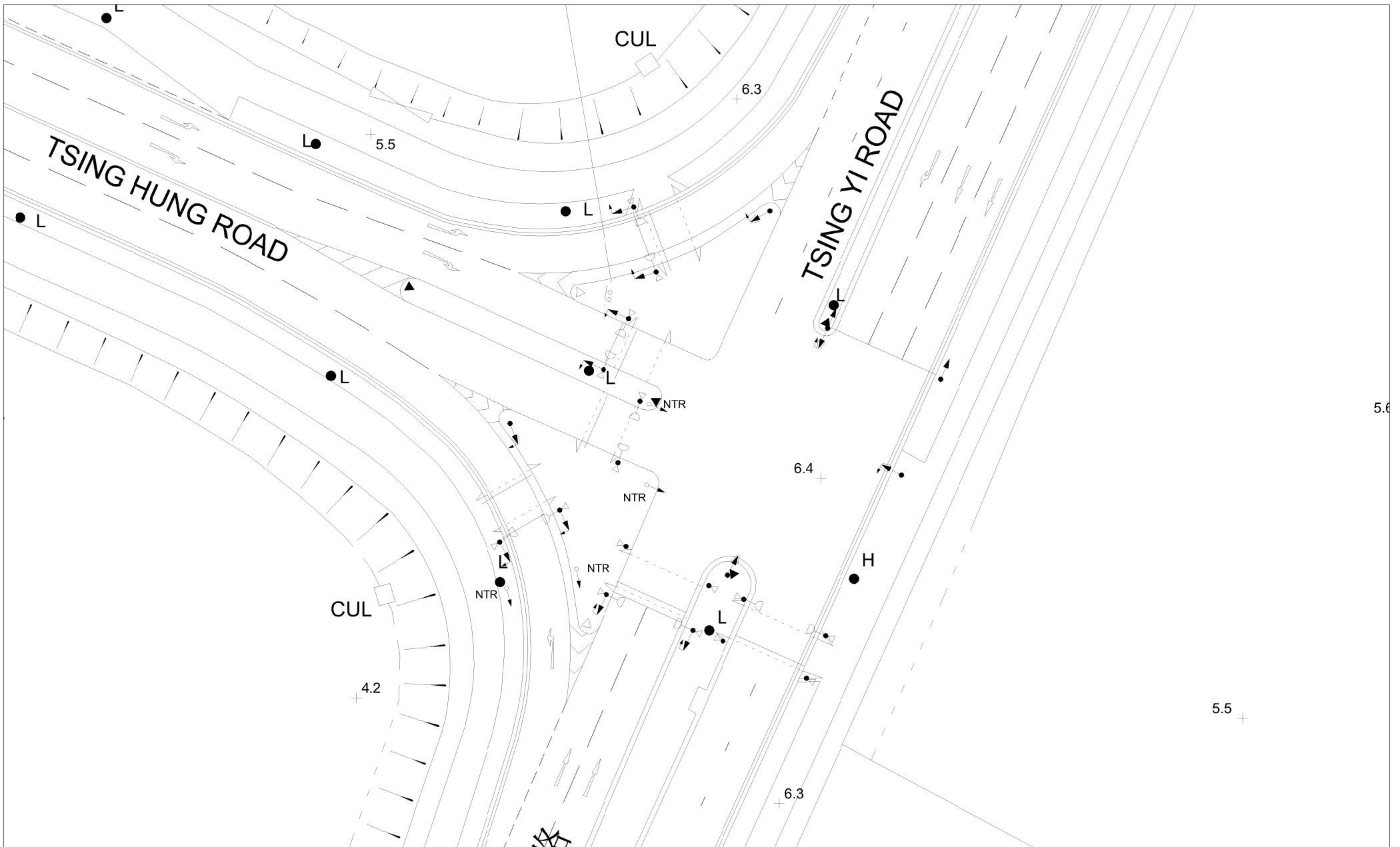

FIGURE NO.:		PROJECT TITLE:	
3.3		Concrete Batching Plant at Tsing Yi - Renewal Application A/TY/139	
PROJECT NO.:		DRAWING TITLE:	
24002HK		EXISTING JUNCTION LAYOUT OF TSING HUNG ROAD / TSING YI ROAD (J2)	
SCALE:	DATE:		
1 : 500 (IN A4 SIZE)	02 MAY 2024		



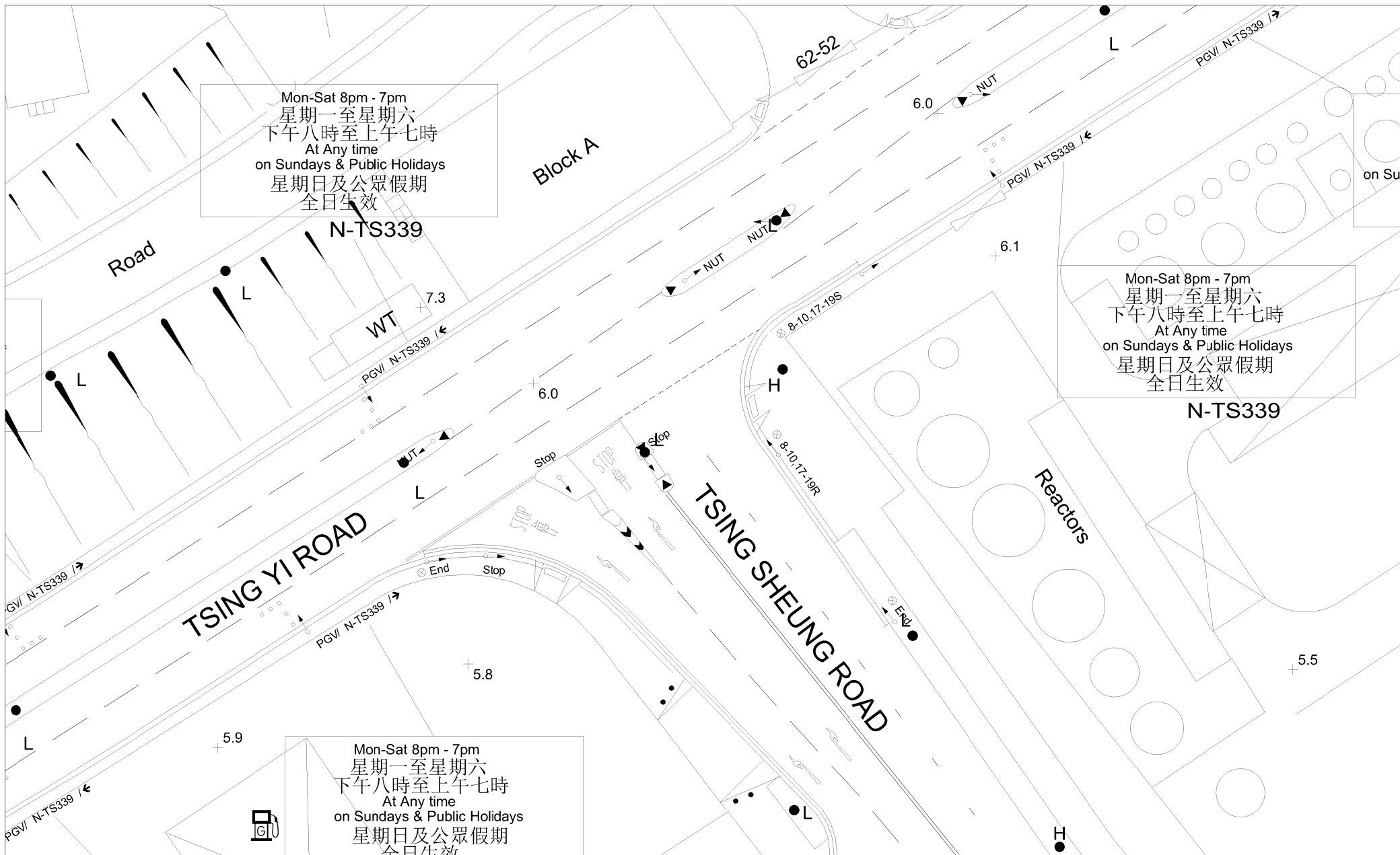

FIGURE NO.:		PROJECT TITLE:	
3.4		Concrete Batching Plant at Tsing Yi - Renewal Application A/TY/139	
PROJECT NO.:		DRAWING TITLE:	
24002HK		EXISTING JUNCTION LAYOUT OF TSING SHEUNG ROAD / TSING YI ROAD (J3)	
SCALE:	DATE:		
1 : 500 (IN A4 SIZE)	02 MAY 2024		



CTA Consultants Limited
志達顧問有限公司

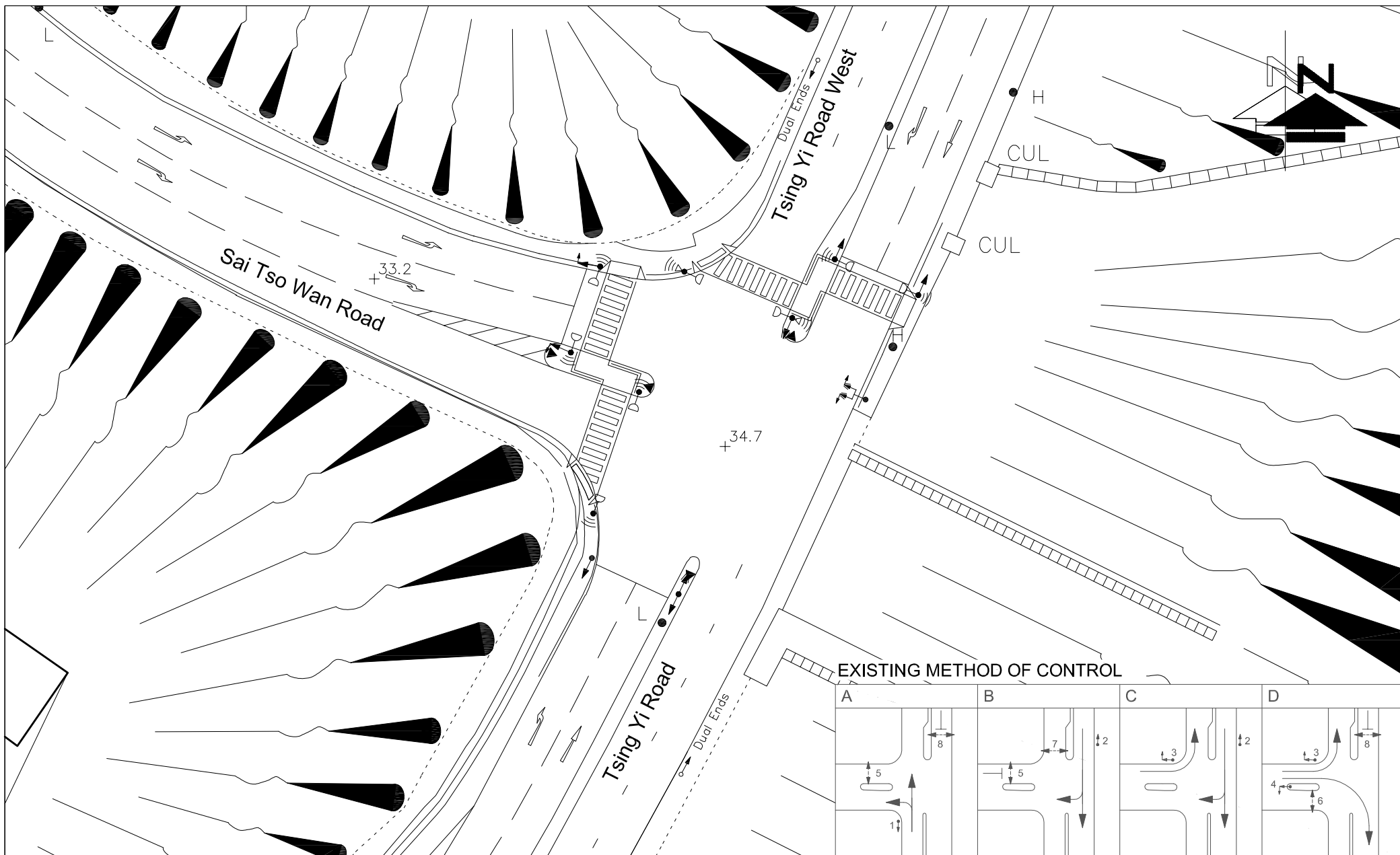



FIGURE NO.:		3.5		PROJECT TITLE:		Concrete Batching Plant at Tsing Yi - Renewal Application A/TY/139	
PROJECT NO.:		24002HK		DRAWING TITLE:			
SCALE:				1 : 500 @A4			
DATE:		02 MAY 2024		<p style="text-align: center;">EXISTING JUNCTION LAYOUT OF SAI TSO WAN ROAD / TSING YI ROAD WEST / TSING YI ROAD (J4)</p>			
 CTA Consultants Limited 志達顧問有限公司							

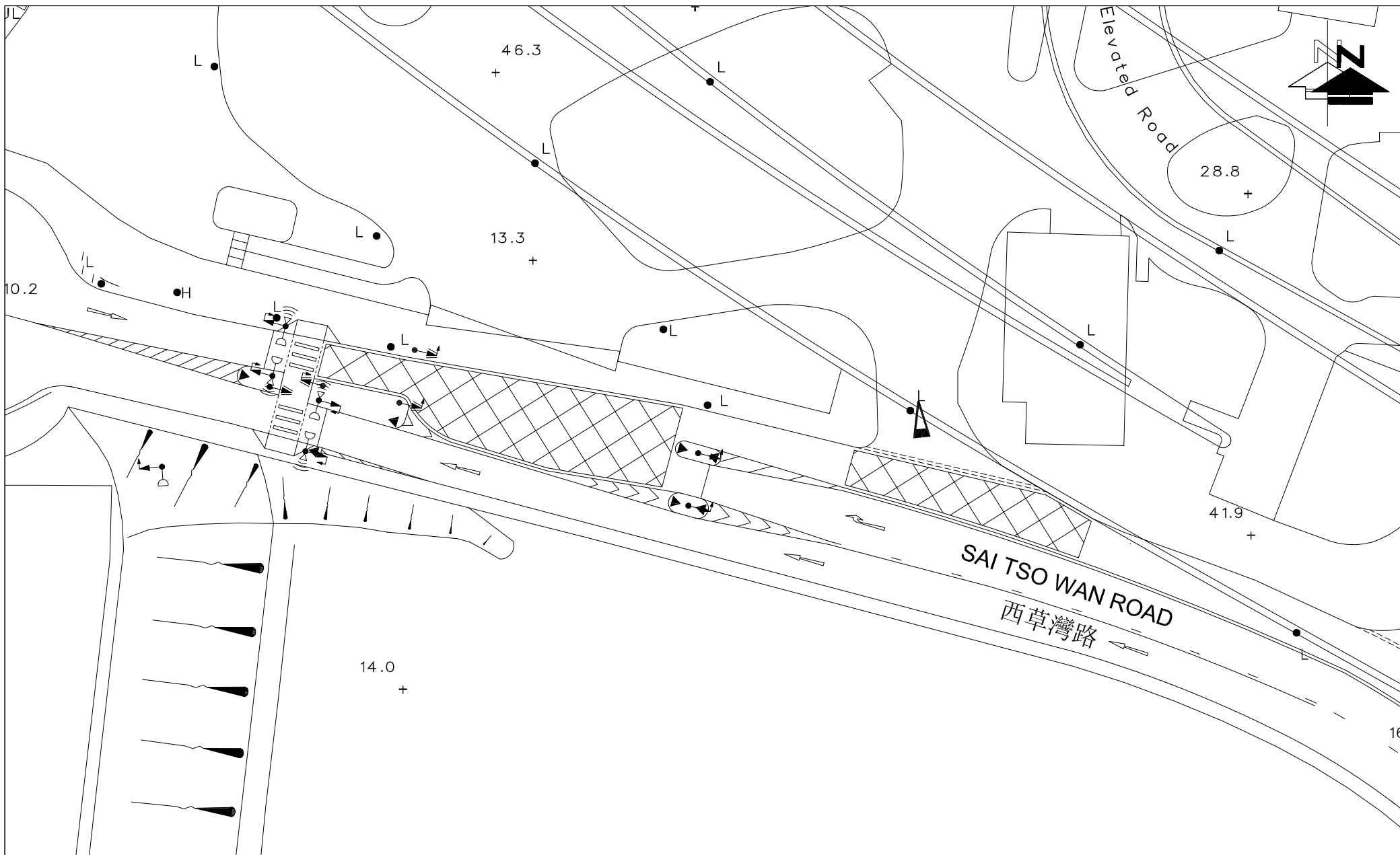



FIGURE NO.: 3.6		PROJECT TITLE: Concrete Batching Plant at Tsing Yi - Renewal Application A/TY/139	 CTA Consultants Limited 志達顧問有限公司
PROJECT NO.: 24002HK		DRAWING TITLE: EXISTING JUNCTION LAYOUT OF ENTRANCE OF VEC / SAI TSO ROAD (J5)	
SCALE: 1 : 500 @A4	DATE: 02 MAY 2024		

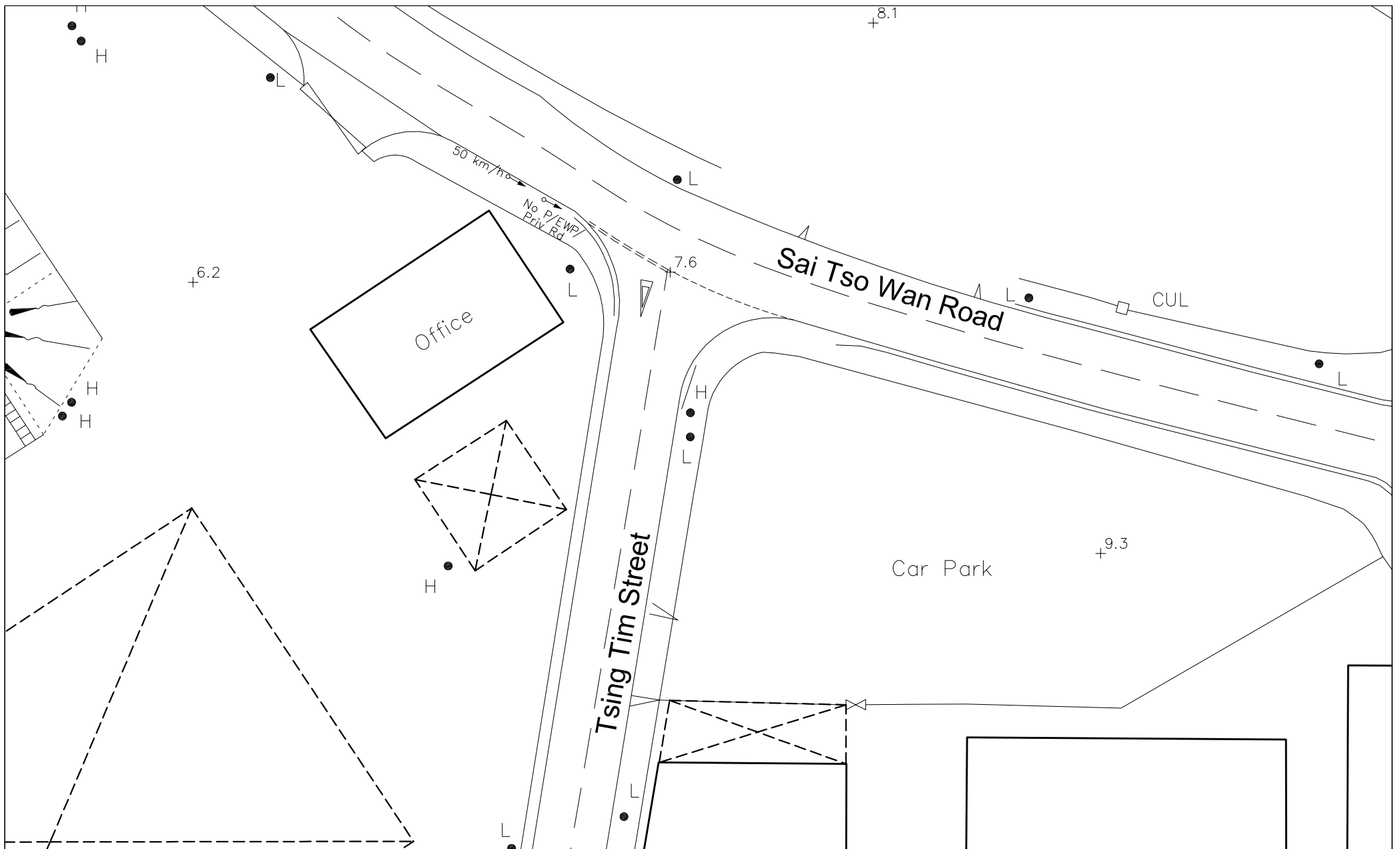



FIGURE NO.: 3.7		PROJECT TITLE: Concrete Batching Plant at Tsing Yi - Renewal Application A/TY/13 9		 CTA Consultants Limited 志達顧問有限公司
PROJECT NO.: 24002HK		DRAWING TITLE: EXISTING JUNCTION LAYOUT OF TSING TIM STREET / SAI TSO WAN ROAD (J6)		
SCALE: 1 : 500 (IN A4 SIZE)	DATE: 02 MAY 2024			

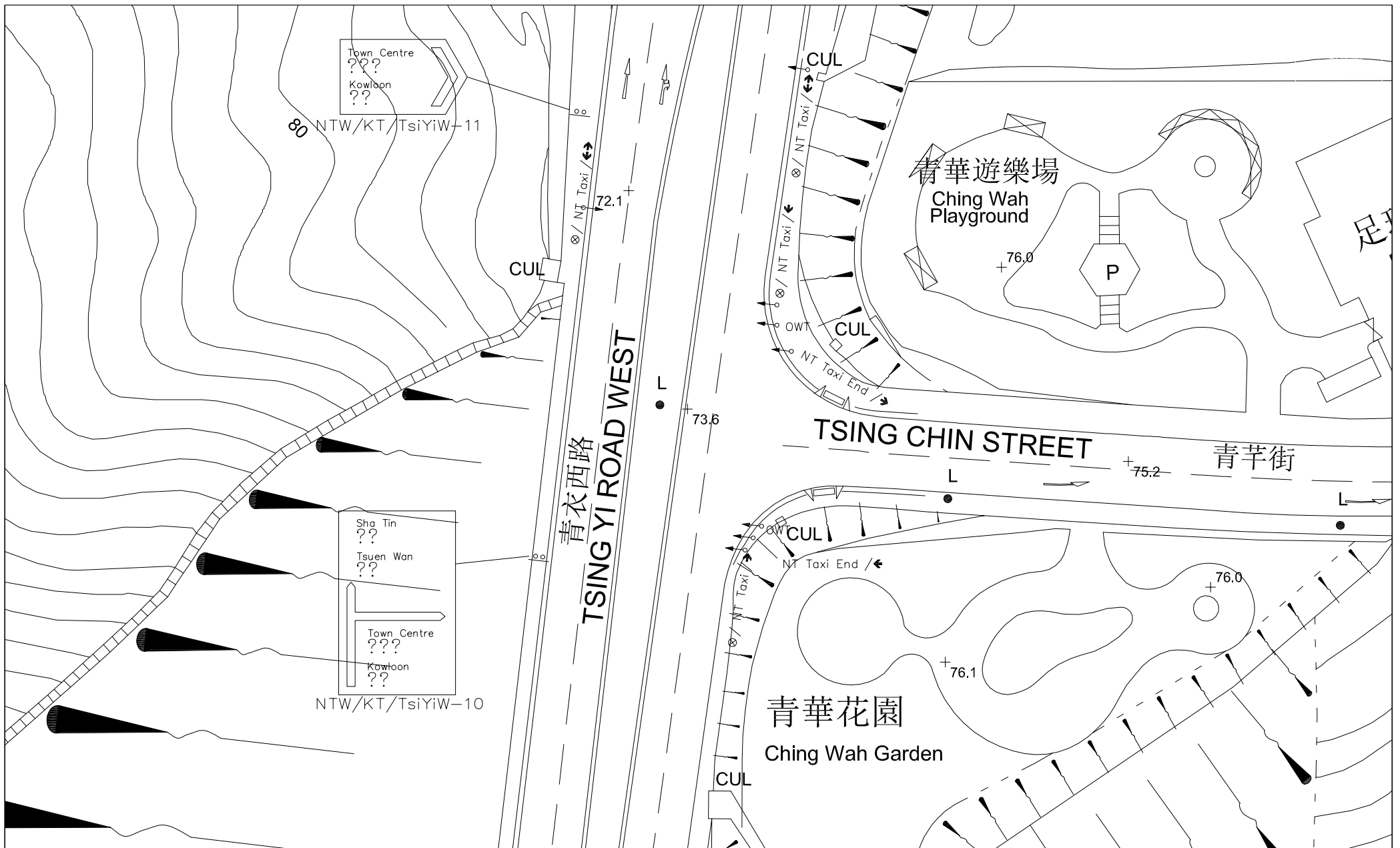



FIGURE NO.: 3.8		PROJECT TITLE: Concrete Batching Plant at Tsing Yi - Renewal Application A/TY/13 9	 CTA Consultants Limited 志達顧問有限公司
PROJECT NO.: 24002HK		DRAWING TITLE: EXISTING JUNCTION LAYOUT OF YI ROAD WEST / TSING CHIN STREET (J7)	
SCALE: 1 : 500 (IN A4 SIZE)	DATE: 02 MAY 2024		

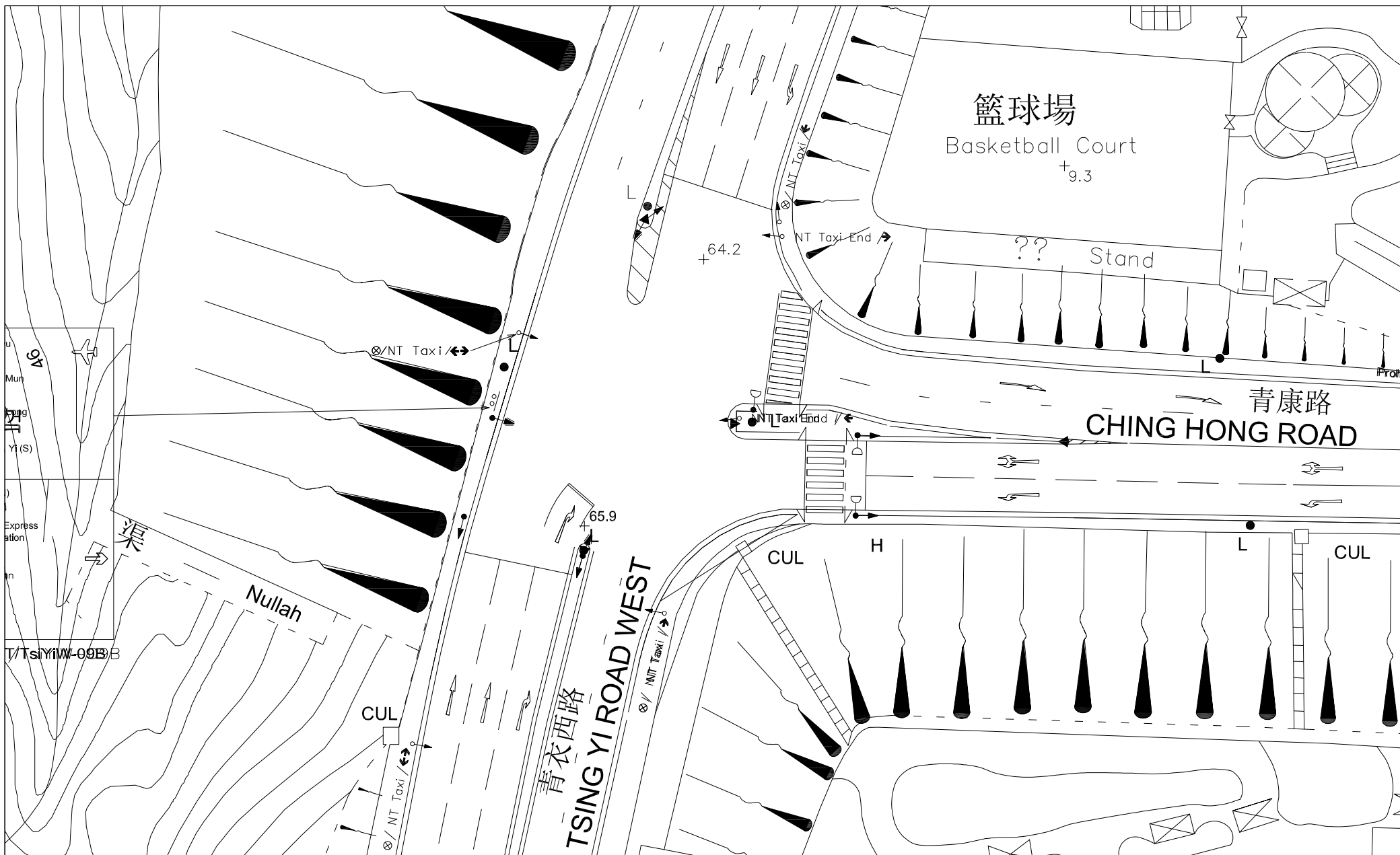



FIGURE NO.: 3.9		PROJECT TITLE: Concrete Batching Plant at Tsing Yi - Renewal Application A/TY/13 9	 CTA Consultants Limited 志達顧問有限公司
PROJECT NO.: 24002HK		DRAWING TITLE: EXISTING JUNCTION LAYOUT OF TSING YI ROAD WEST / TSING HONG ROAD (J8)	
SCALE: 1 : 500 (IN A4 SIZE)	DATE: 02 MAY 2024		

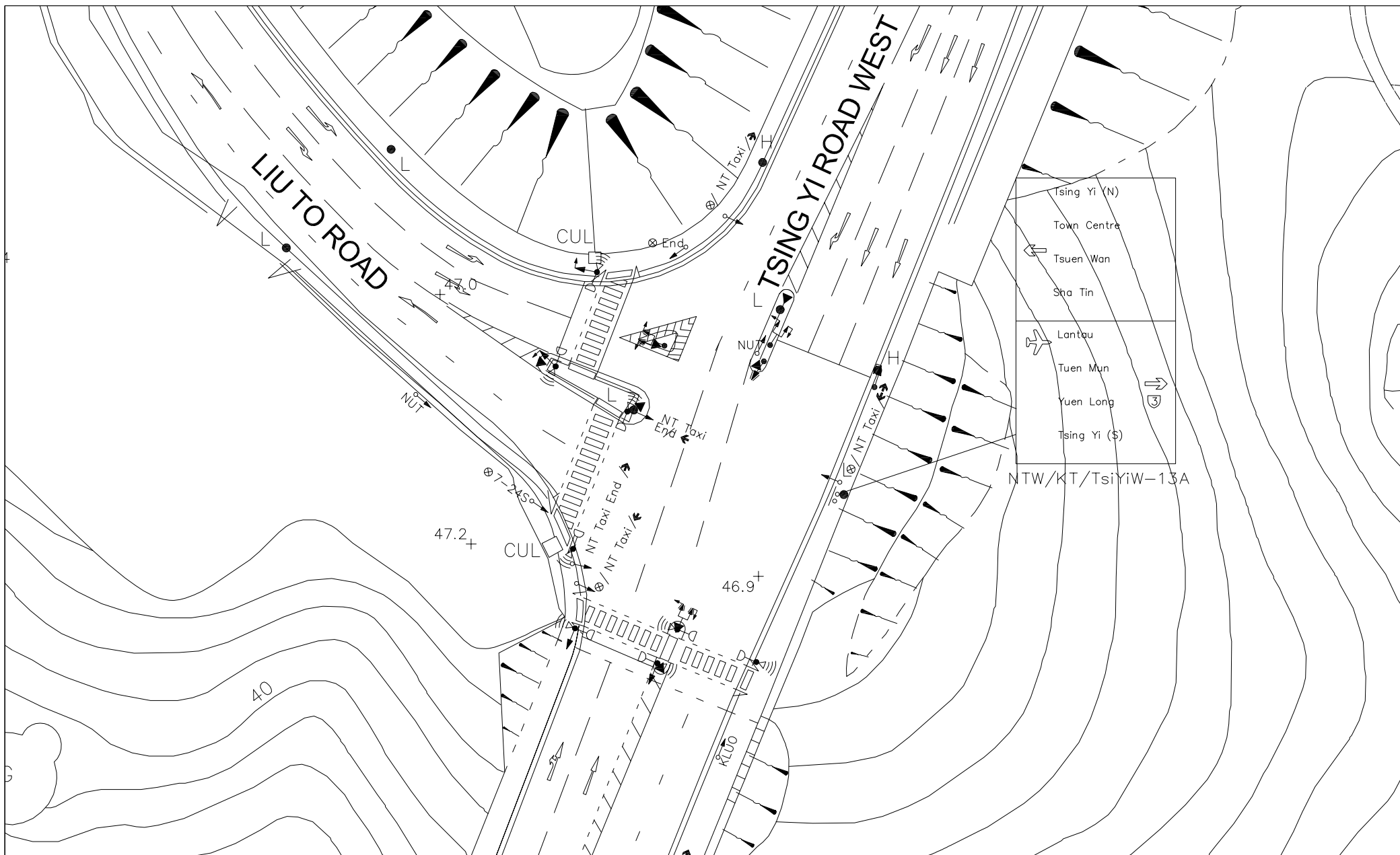



FIGURE NO.: 3.10		PROJECT TITLE: Concrete Batching Plant at Tsing Yi - Renewal Application A/TY/13 9	 CTA Consultants Limited 志達顧問有限公司
PROJECT NO.: 24002HK		DRAWING TITLE: EXISTING JUNCTION LAYOUT OF TSING YI ROAD WEST / LIU TO ROAD (J9)	
SCALE: 1 : 500 (IN A4 SIZE)	DATE: 02 MAY 2024		

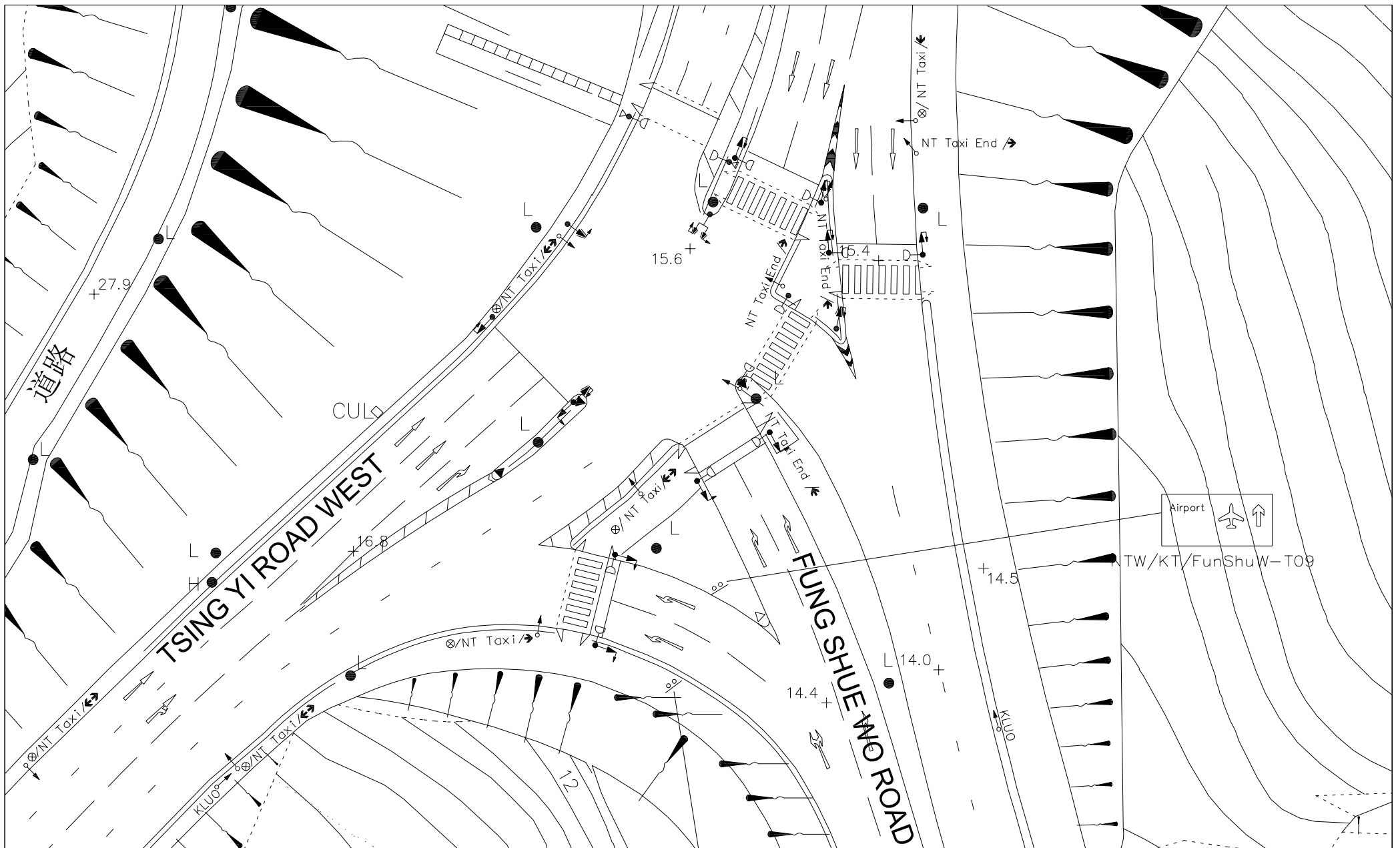

FIGURE NO.: 3.11		PROJECT TITLE: Concrete Batching Plant at Tsing Yi - Renewal Application A/TY/13 9
PROJECT NO.: 24002HK		DRAWING TITLE: EXISTING JUNCTION LAYOUT OF TSING YI ROAD WEST / FUNG SHUE WO ROAD (J10)
SCALE: 1 : 500 (IN A4 SIZE)	DATE: 02 MAY 2024	



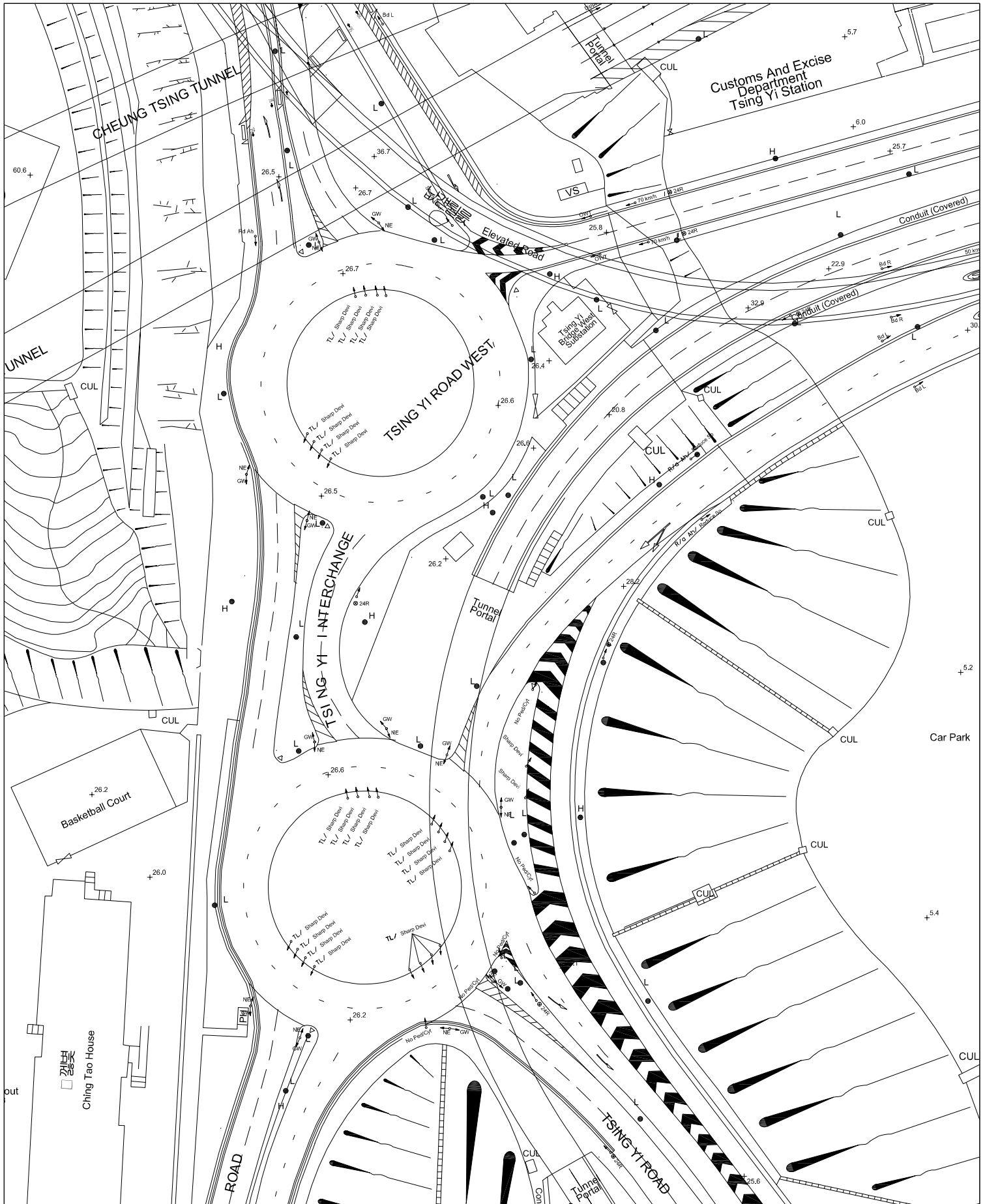

FIGURE NO.:
3.12

PROJECT TITLE:
Concrete Batching Plant at Tsing Yi - Renewal Application A/TY/13 9

PROJECT NO.:
24002HK

DRAWING TITLE:
**EXISTING JUNCTION LAYOUT OF
SING YI INTERCHANGE (RA1)**

SCALE:
1 : 1000
(IN A4 SIZE)

DATE:
02 MAY 2024



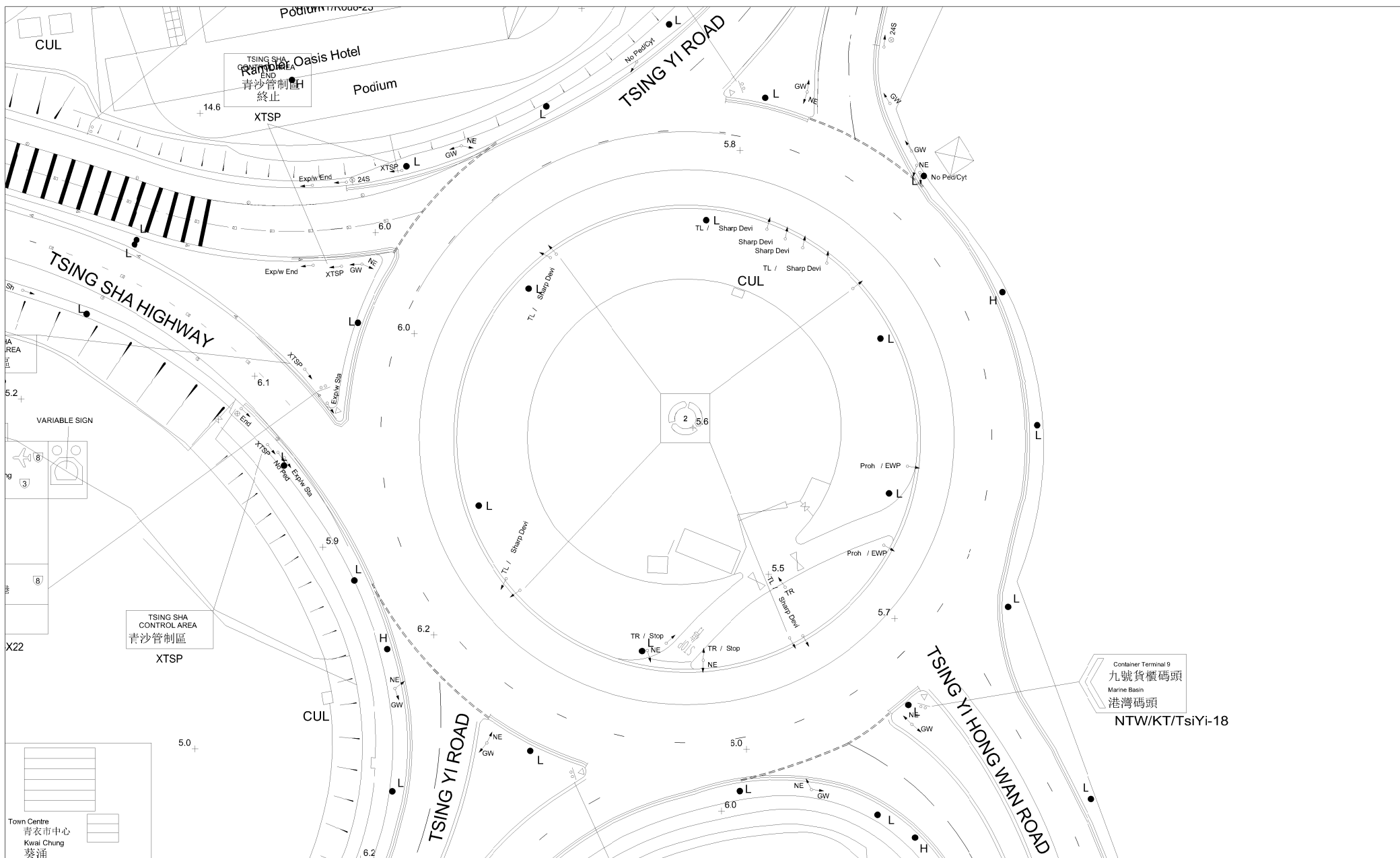

FIGURE NO.:		PROJECT TITLE:	
3.13		Concrete Batching Plant at Tsing Yi - Renewal Application A/TY/139	
PROJECT NO.:		DRAWING TITLE:	
24002HK		EXISTING JUNCTION LAYOUT OF TSING YI ROAD WEST / TSING YI HONG WAN ROAD / TSING SHA HIGHWAY (RA2)	
SCALE:	DATE:		
1 : 500 (IN A4 SIZE)	02 MAY 2024		



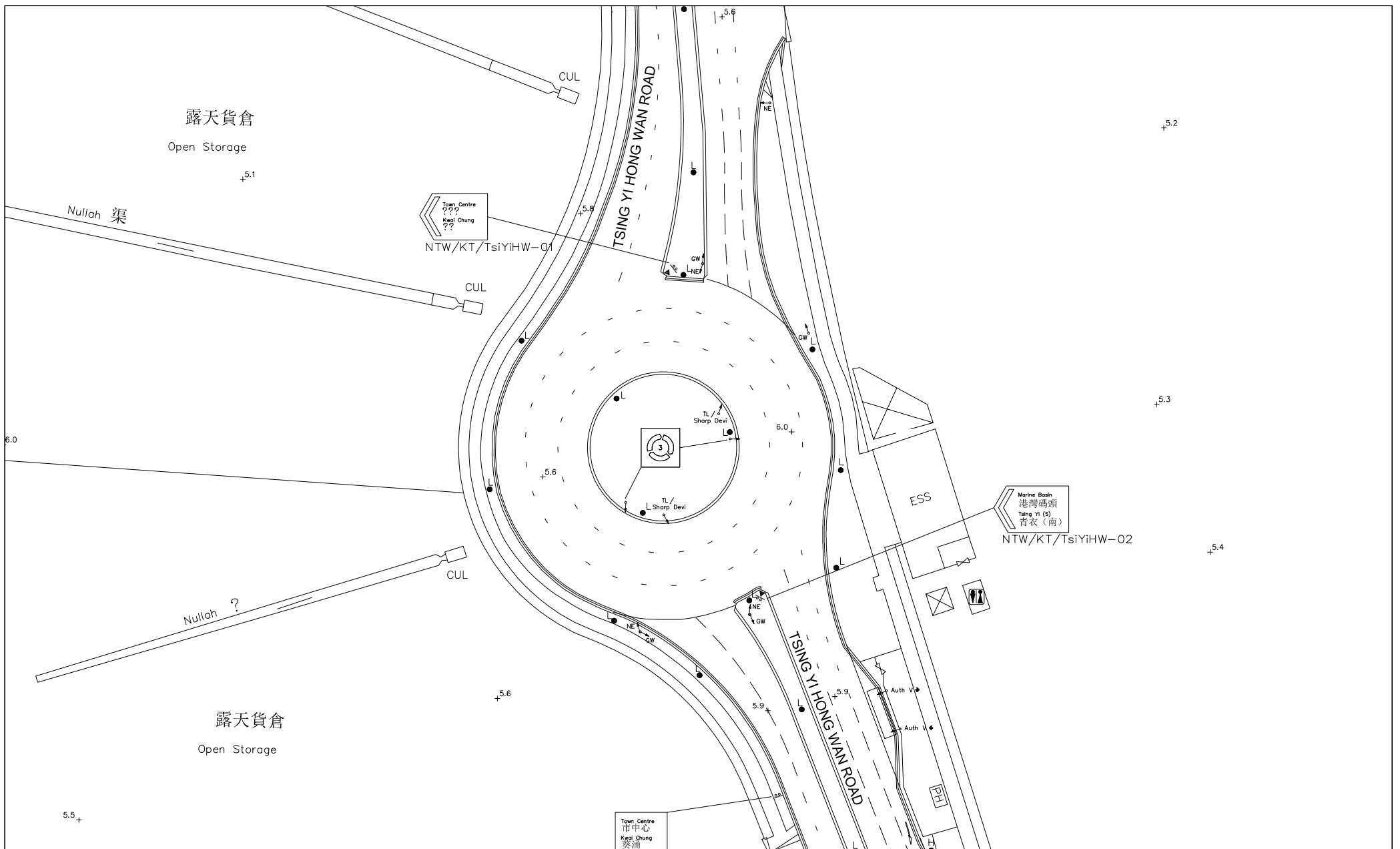



FIGURE NO.: 3.14		PROJECT TITLE: Concrete Batching Plant at Tsing Yi - Renewal Application A/TY/13 9	 CTA Consultants Limited 志達顧問有限公司
PROJECT NO.: 24002HK		DRAWING TITLE: EXISTING JUNCTION LAYOUT OF TSING YI ROAD WEST / FUNG SHUE WO ROAD (RA3)	
SCALE: 1 : 1000 (IN A4 SIZE)	DATE: 02 MAY 2024		

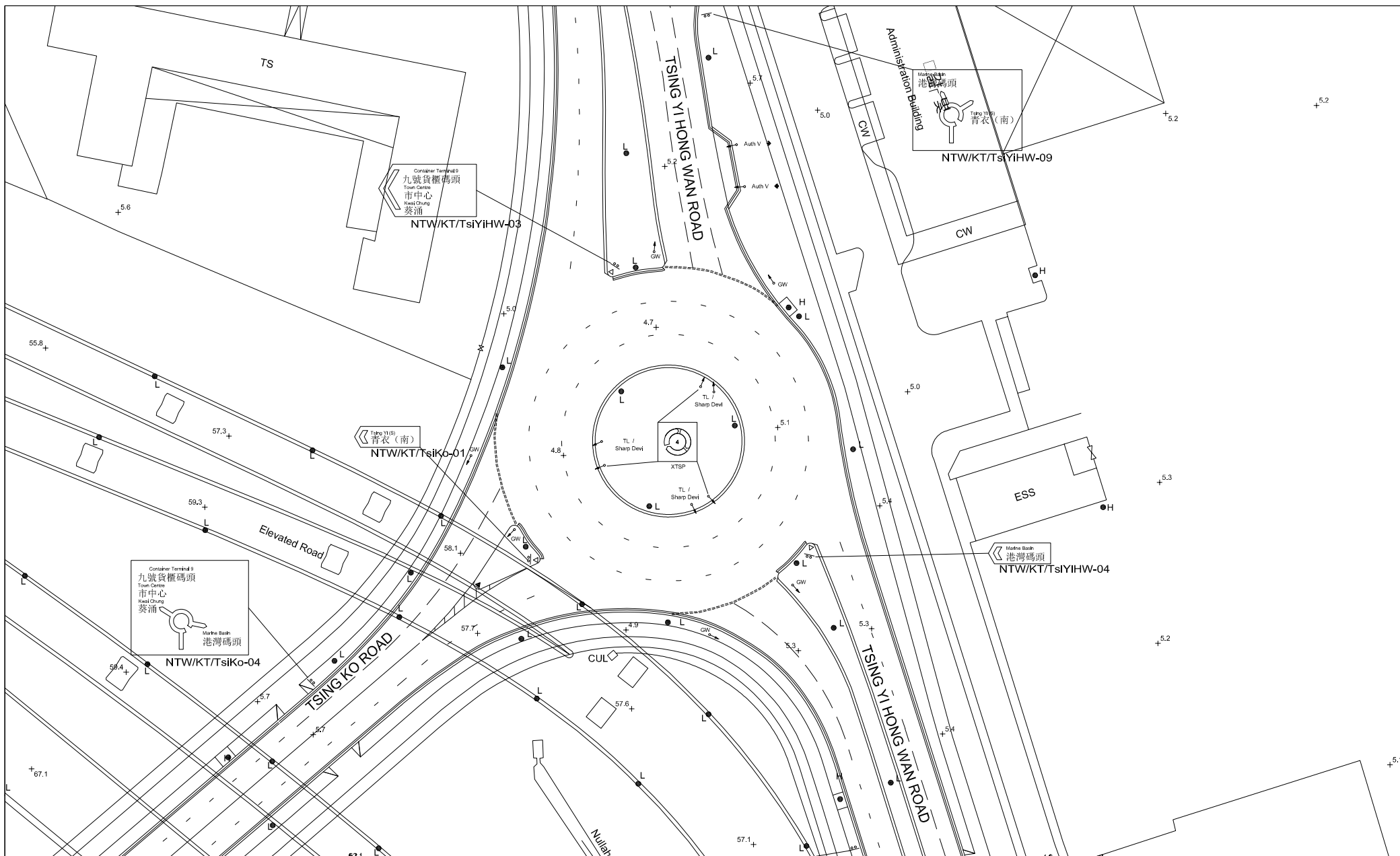

FIGURE NO.:		3.15		PROJECT TITLE:		Concrete Batching Plant at Tsing Yi - Renewal Application A/TY/13 9	
PROJECT NO.:		24002HK		DRAWING TITLE:		EXISTING JUNCTION LAYOUT OF TSING YI HONG WAN ROAD / TSING KO ROAD (RA4)	
SCALE:	DATE:						
1 : 1000 (IN A4 SIZE)	02 MAY 2024						



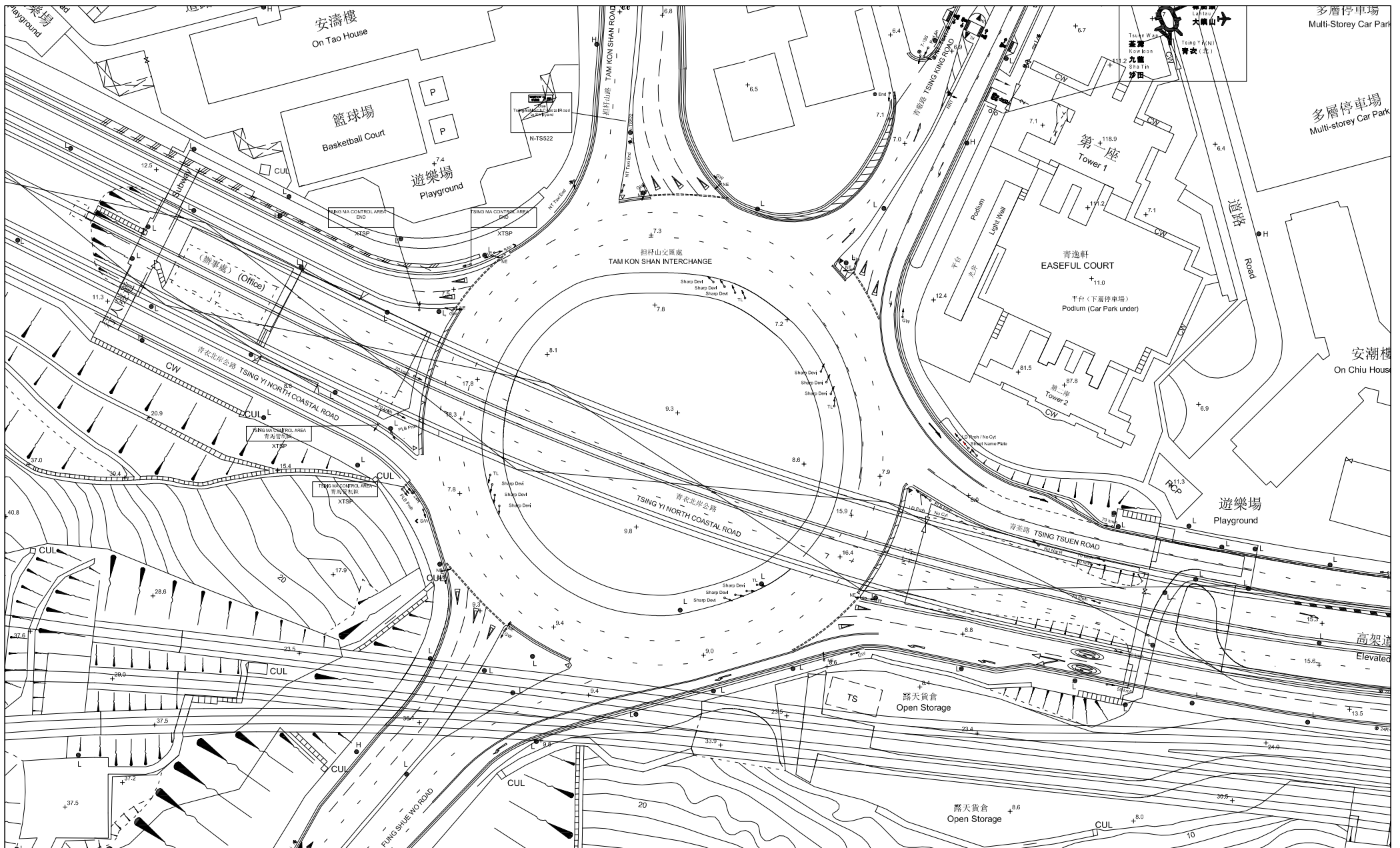



FIGURE NO.: 3.16		PROJECT TITLE: Concrete Batching Plant at Tsing Yi - Renewal Application A/TY/13 9	 CTA Consultants Limited 志達顧問有限公司
PROJECT NO.: 24002HK		DRAWING TITLE: EXISTING JUNCTION LAYOUT OF TAM KON SHAN INTERCHANGE (RA5)	
SCALE: 1 : 1200 (IN A4 SIZE)	DATE: 02 MAY 2024		

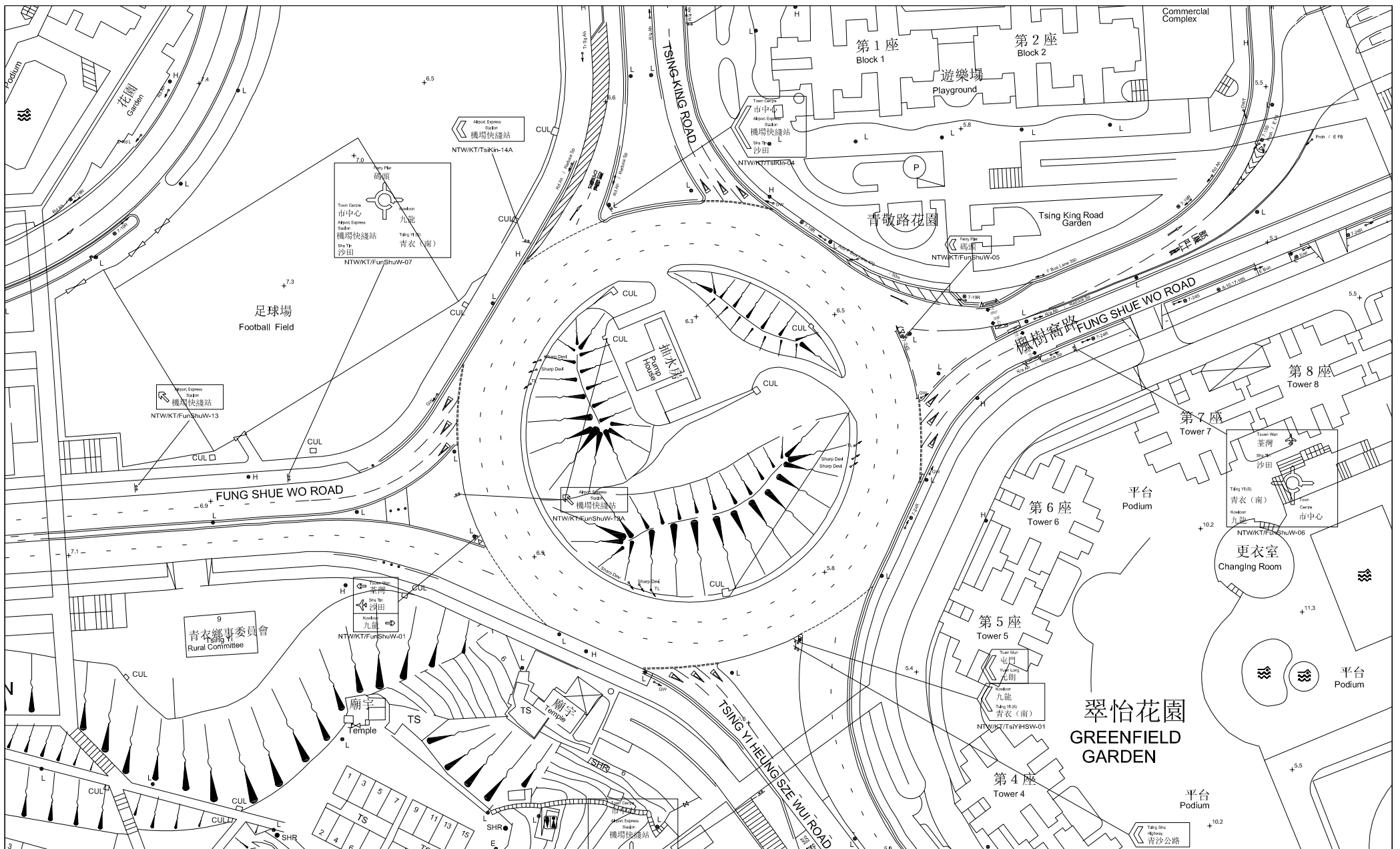

FIGURE NO.:		PROJECT TITLE:	
3.17		Concrete Batching Plant at Tsing Yi - Renewal Application A/TY/13 9	
PROJECT NO.:		DRAWING TITLE:	
24002HK		EXISTING JUNCTION LAYOUT OF TSING YI HEUNG SZE WUI ROAD / FUNG SHUE WO ROAD / TSING KING ROAD (RA6)	
SCALE:	DATE:		
1 : 1200 (IN A4 SIZE)	02 MAY 2024		



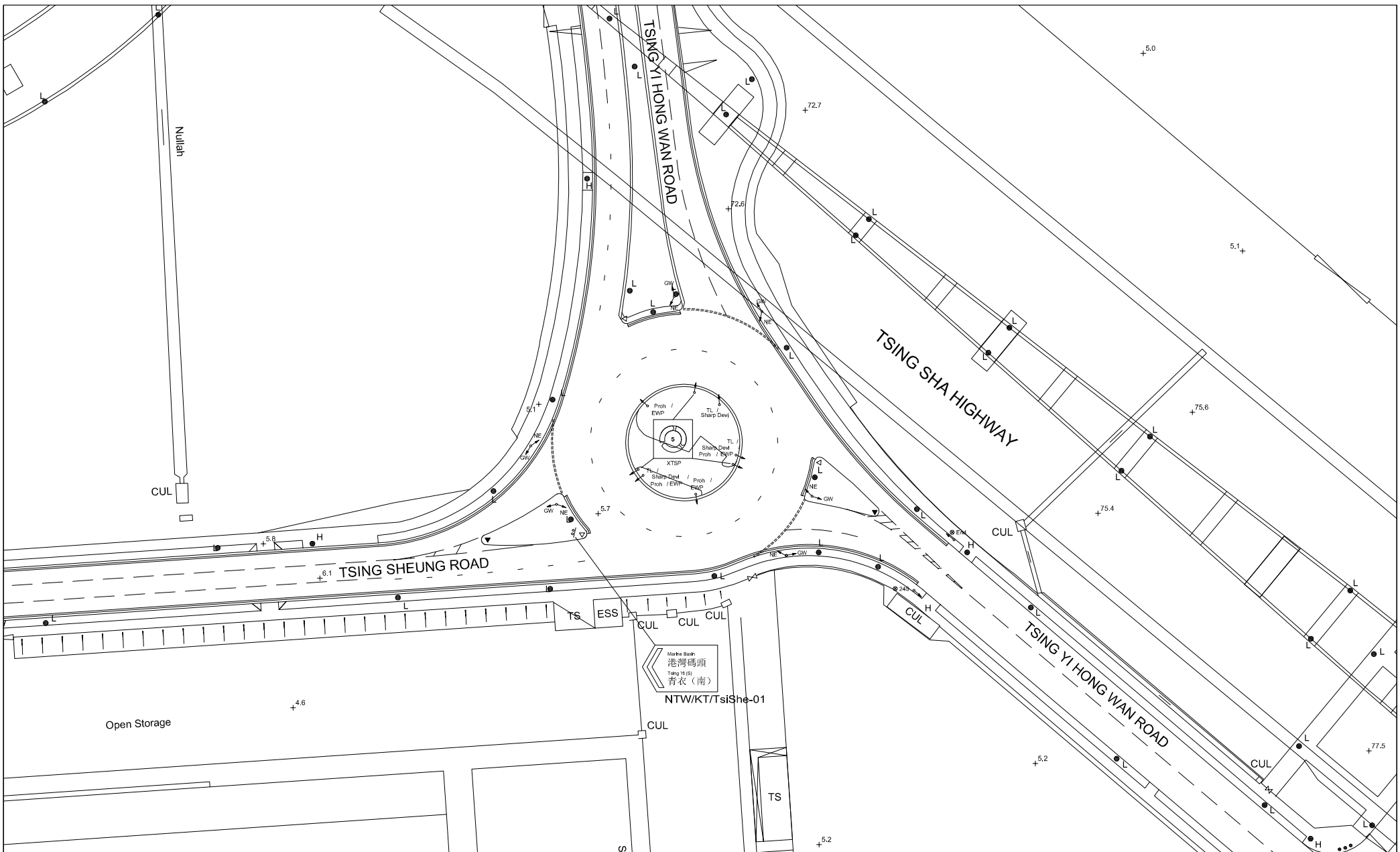

FIGURE NO.:	3.18	PROJECT TITLE:	Concrete Batching Plant at Tsing Yi - Renewal Application A/TY/13 9
PROJECT NO.:	24002HK	DRAWING TITLE:	EXISTING JUNCTION LAYOUT OF TSING SHEUNG ROAD / TSING YI HONG WAN ROAD (RA7)
SCALE: 1 : 1000 (IN A4 SIZE)	DATE: 02 MAY 2024		



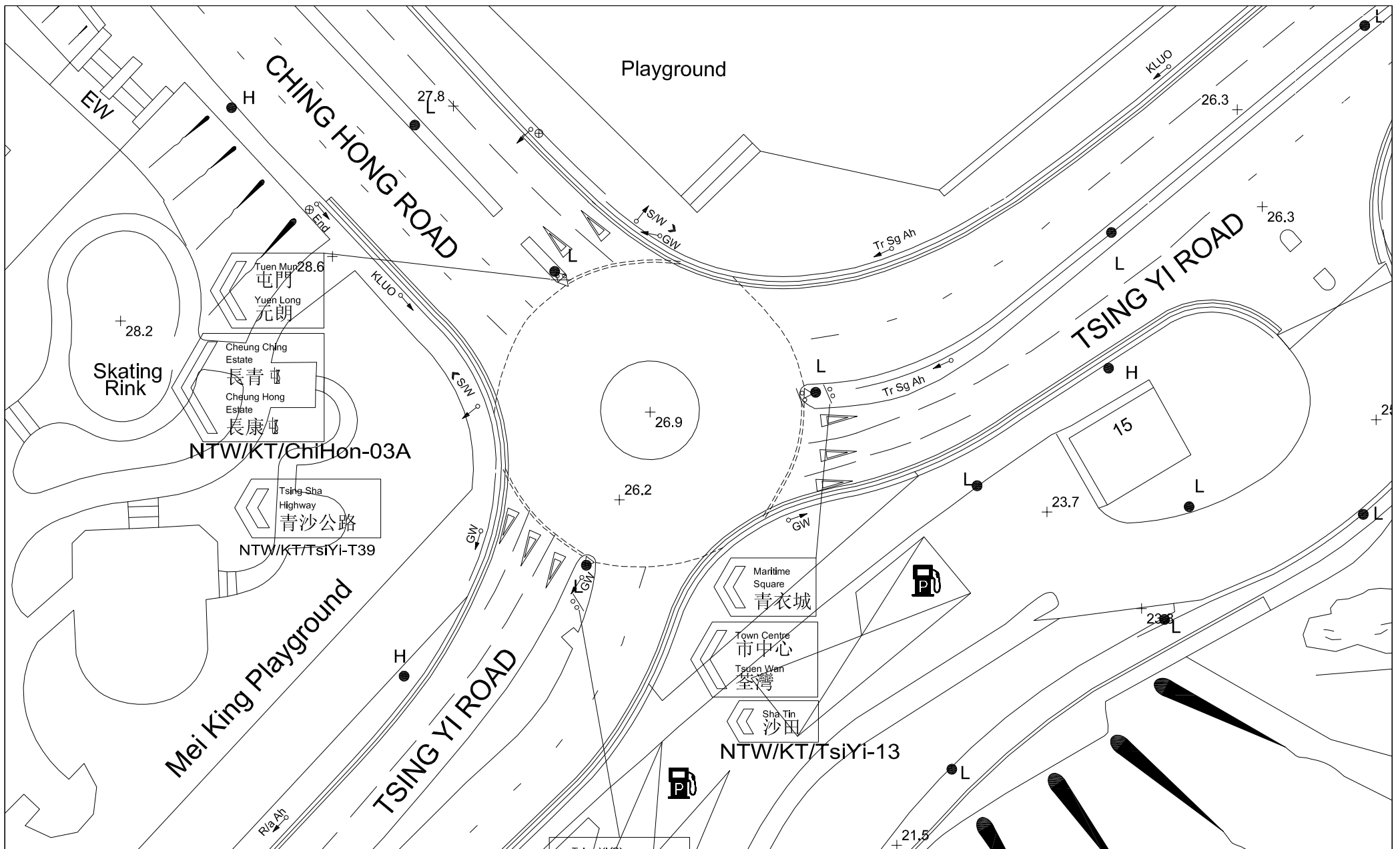



FIGURE NO.: 3.19		PROJECT TITLE: Concrete Batching Plant at Tsing Yi - Renewal Application A/TY/13 9	 CTA Consultants Limited 志達顧問有限公司
PROJECT NO.: 24002HK		DRAWING TITLE: EXISTING JUNCTION LAYOUT OF TSING HONG ROAD / TSING YI ROAD (RA8)	
SCALE: 1 : 500 (IN A4 SIZE)	DATE: 02 MAY 2024		

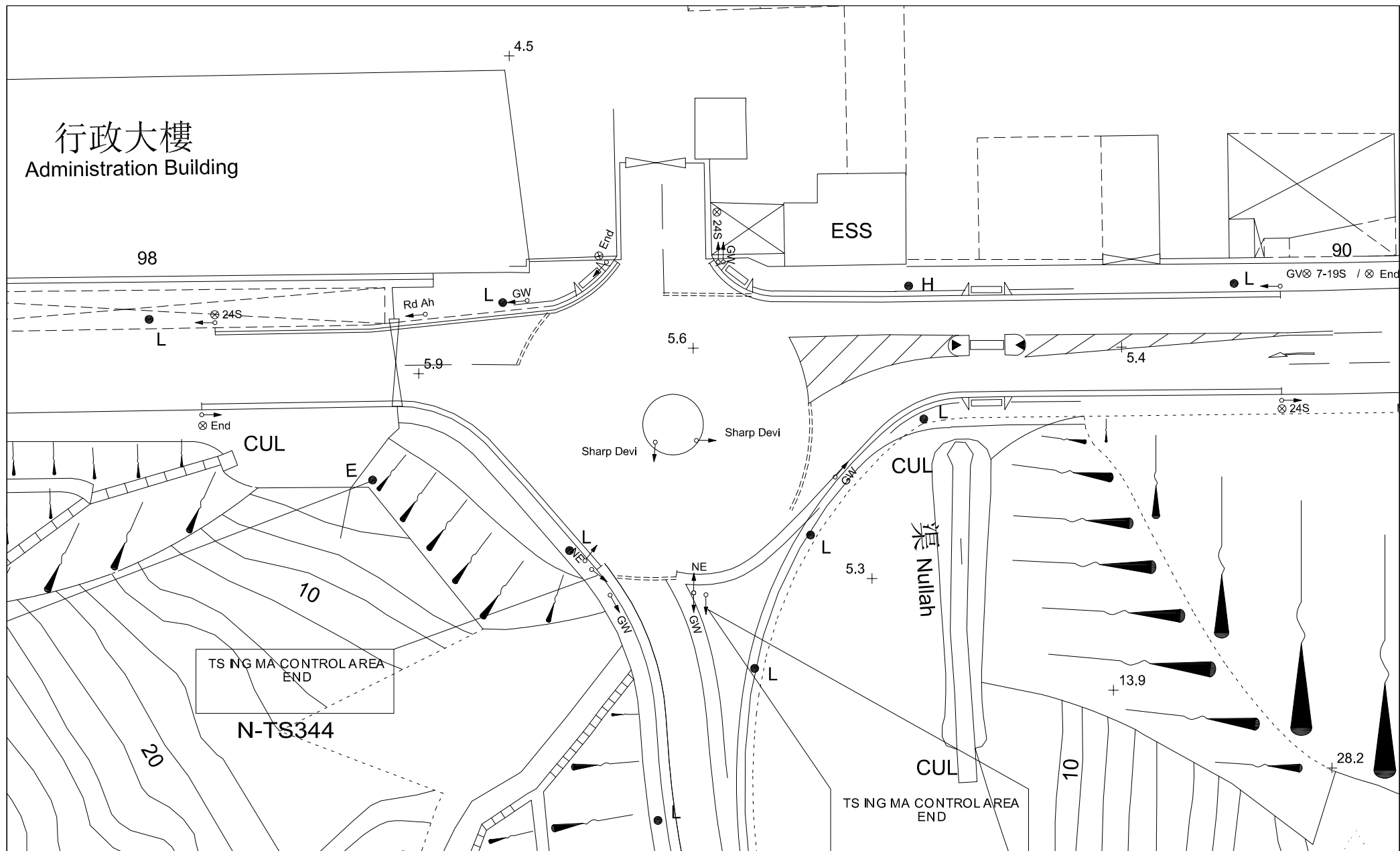

FIGURE NO.: 3.20		PROJECT TITLE: Concrete Batching Plant at Tsing Yi - Renewal Application A/TY/13 9
PROJECT NO.: 24002HK		DRAWING TITLE: EXISTING JUNCTION LAYOUT OF TAM KON SHAN ROAD / TSING YI NORTH COSTAL ROAD (RA9)
SCALE: 1 : 500 (IN A4 SIZE)	DATE: 02 MAY 2024	



CTA Consultants Limited
志達顧問有限公司

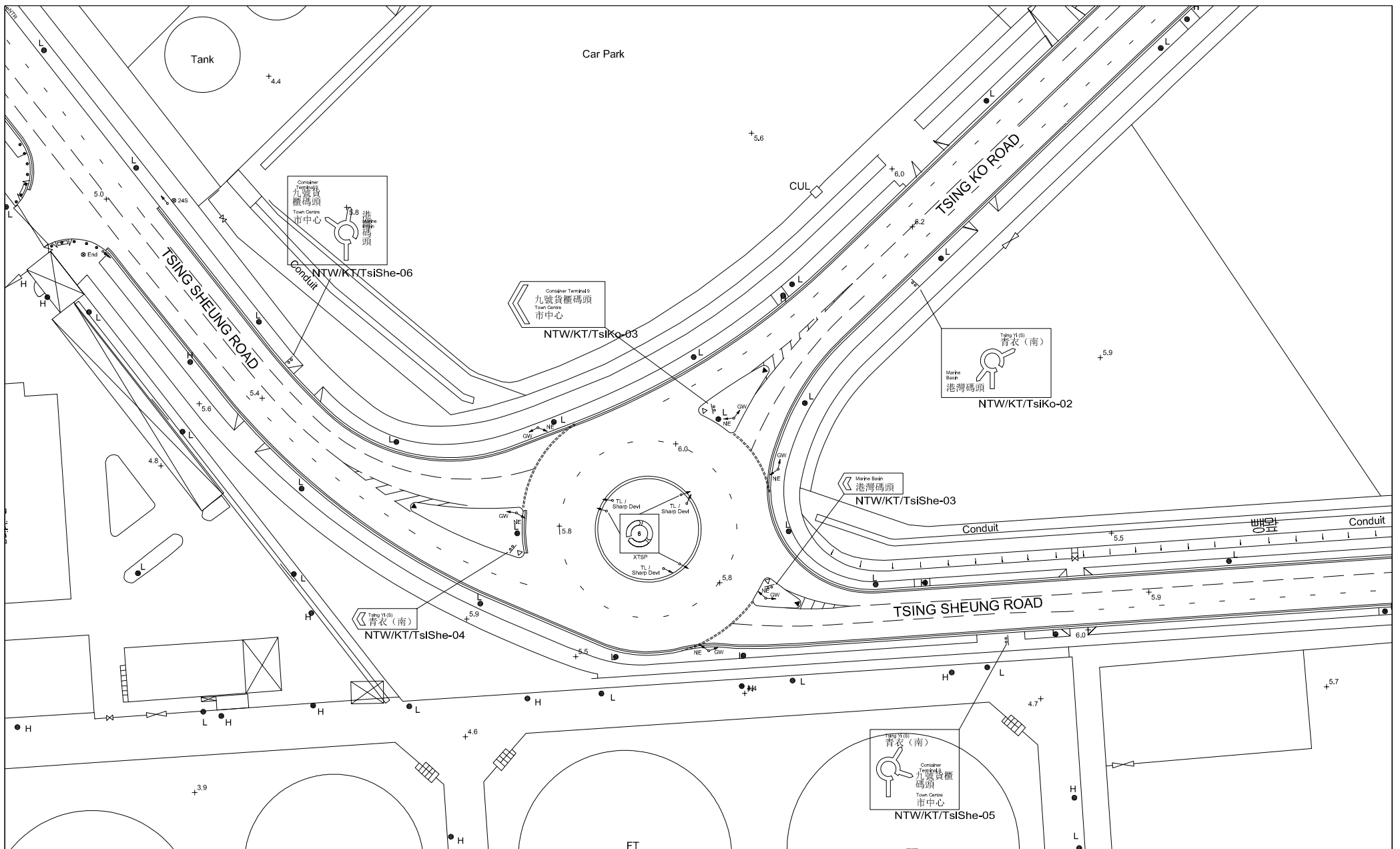



FIGURE NO.: 3.21		PROJECT TITLE: Concrete Batching Plant at Tsing Yi - Renewal Application A/TY/13 9	 CTA Consultants Limited 志達顧問有限公司
PROJECT NO.: 24002HK		DRAWING TITLE: EXISTING JUNCTION LAYOUT OF TSING KO ROAD / TSING SHEUNG ROAD (RA10)	
SCALE: 1 : 1000 (IN A4 SIZE)	DATE: 02 MAY 2024		

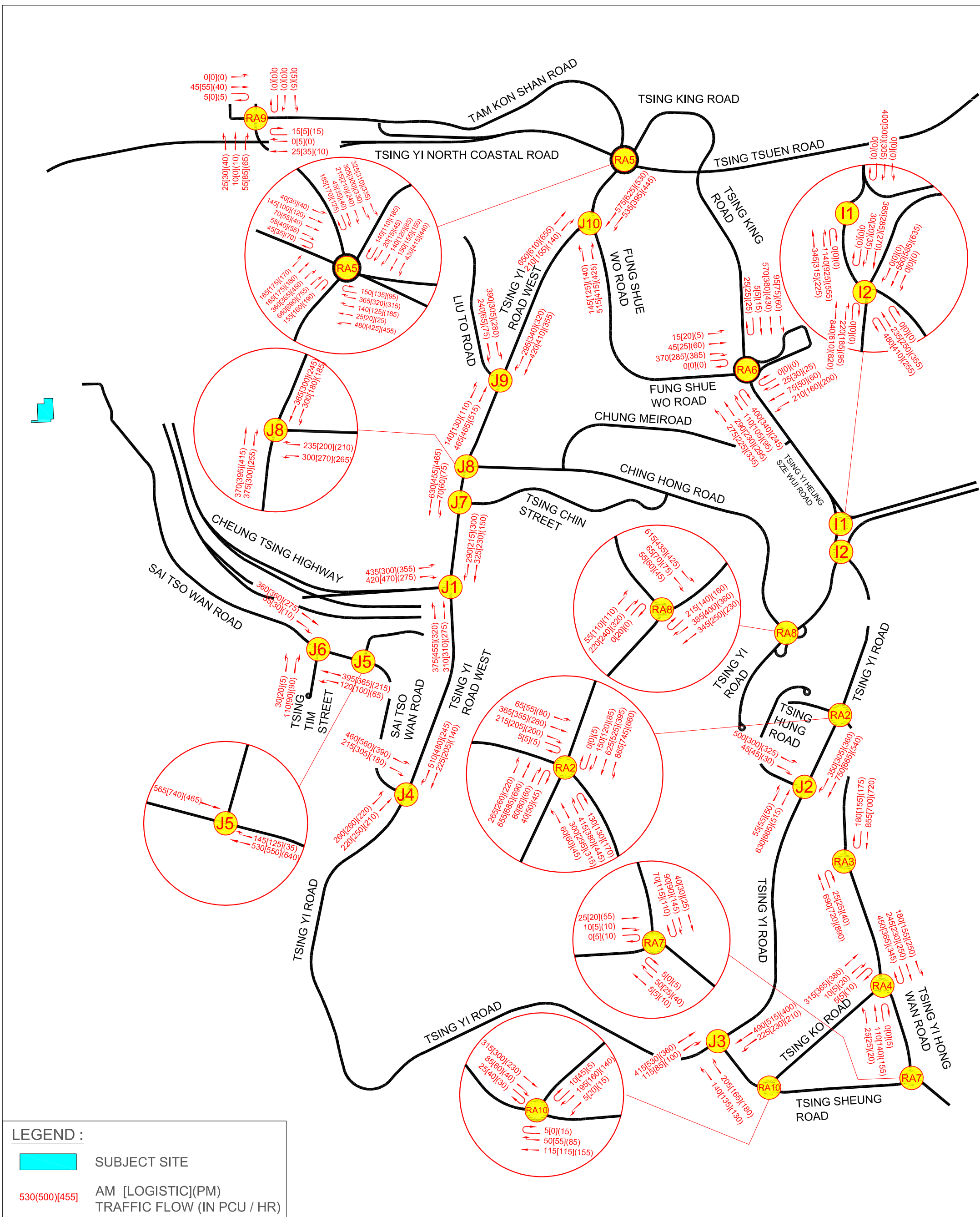
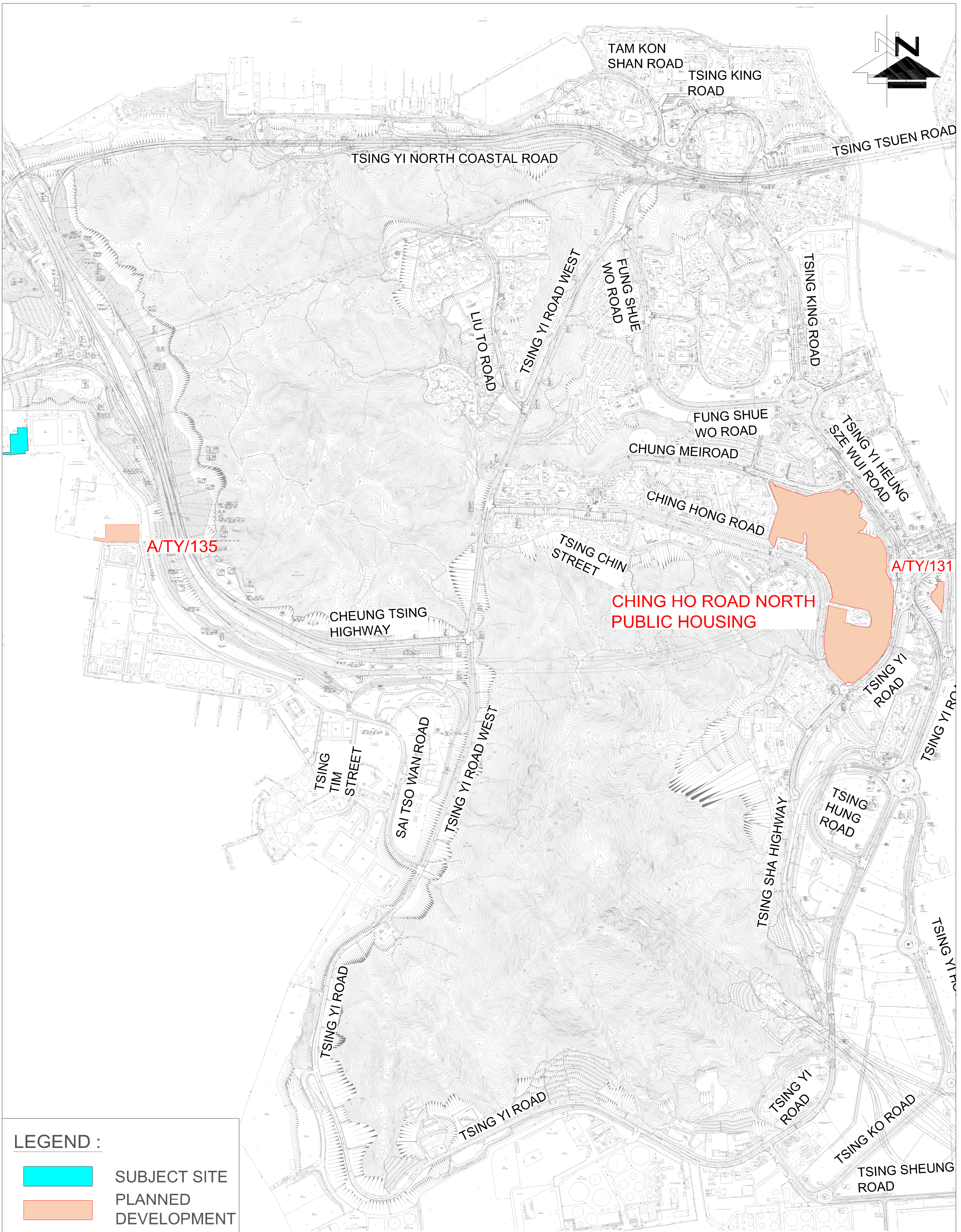

FIGURE NO.:		3.22		PROJECT TITLE:		Concrete Batching Plant at Tsing Yi - Renewal Application A/TY/13 9	
PROJECT NO.:		24002HK		DRAWING TITLE:		2024 OBSERVED TRAFFIC FLOW	
SCALE:	DATE:					CTA Consultants Limited 志達顧問有限公司	
1 : 12000 @ A3	02 MAY 2024						



LEGEND :



SUBJECT SITE



PLANNED DEVELOPMENT

FIGURE NO.:	4.1
PROJECT NO.:	24002HK
SCALE:	DATE:
1 : 11000 @A3	02 MAY 2024

PROJECT TITLE:	Concrete Batching Plant at Tsing Yi - Renewal Application ATY/139
DRAWING TITLE:	PLANNED DEVELOPMENT IN VICINITY

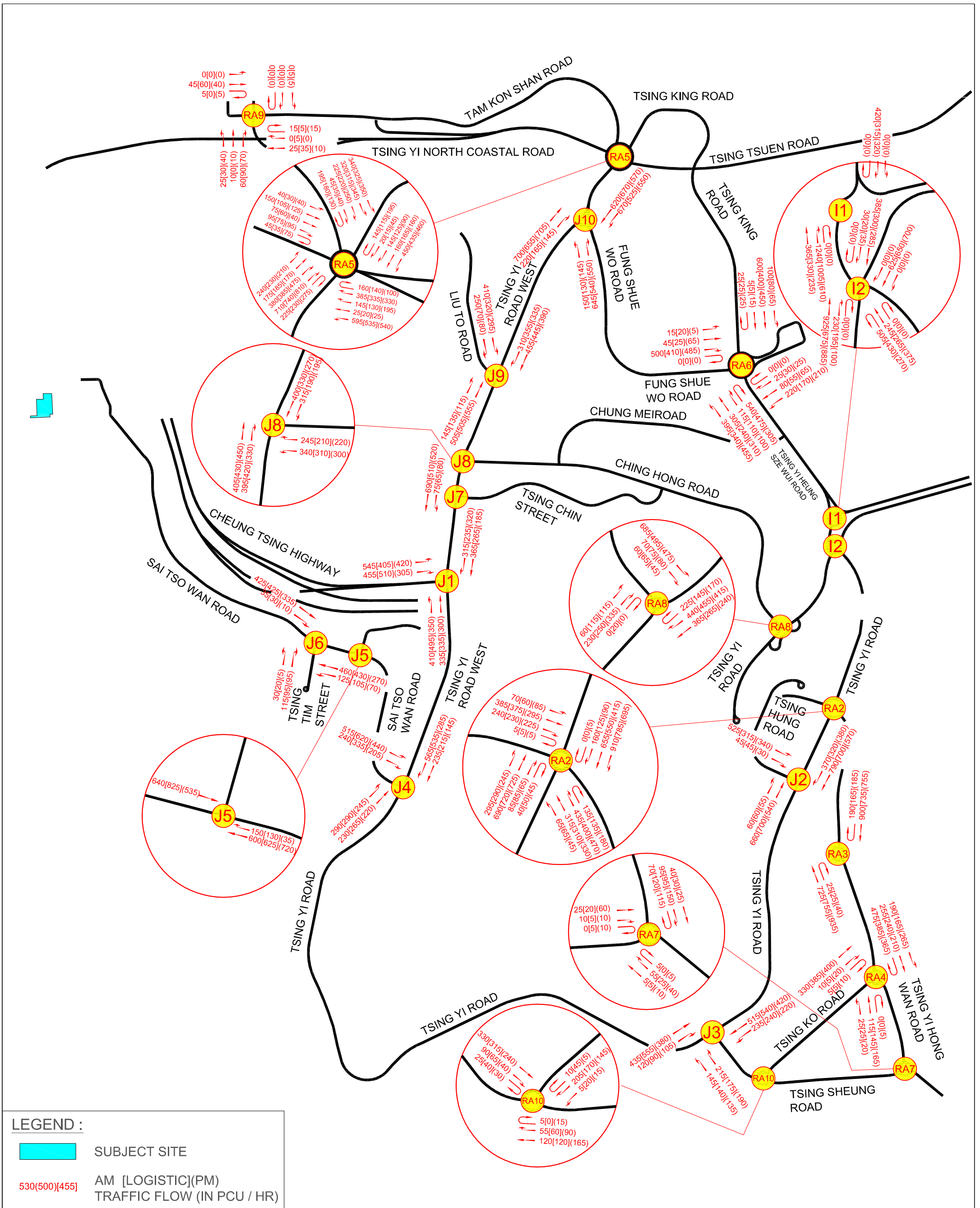



FIGURE NO.:	5.1	PROJECT TITLE:	Concrete Batching Plant at Tsing Yi - Renewal Application A/TY/13 9
PROJECT NO.:	24002HK	DRAWING TITLE:	2029 DESIGN TRAFFIC FLOW
SCALE:	DATE:		
1 : 12000 @ A3	02 MAY 2024		



Appendix 1

Junction Calculation Sheets

Junction: (J1) Tsing Yi Road West / Cheung Tsing Highway
 Description: 2024 Observed Traffic Flow

Approach	Direction	Movement notation	Phase	Stage	Radius (m)		Nearside 0/1	Pro. Turning (%)		Saturation Flow (pcu/hr)	Total Saturation Flow (pcu/hr)	Revised Saturation Flow (pcu/hr)		Total Revised Saturation Flow (pcu/hr)		A.M. Peak			P.M. Peak			
					Left	Right		A.M.	P.M.			A.M.	P.M.	A.M.	P.M.	Flow (pcu/hr)	y Value	Critical y	Flow (pcu/hr)	y Value	Critical y	
																						Width (m)
Tsing Yi Road West	S	↓	2	A	3.5	0	0	0%	0%	2105	6135	2105	2105	5905	5835	219	0.104	0.104	150	0.071	0.080	
	S	↙	2	A	3.3	0	20	0	49%	100%	2085	0	2010	1940	0	0	209	0.104		156	0.080	
	S	↘	3	A	3.3	0	17.5	1	100%	100%	1945	0	1790	1790	0	0	186	0.104		144	0.080	
Cheung Tsing Highway	E	↗	3	A,B	3.4	20	0	1	100%	100%	1955	1955	1820	1820	1820	1820	435	0.239		355	0.195	
	E	↘	4	B	3.5	0	30	0	100%	100%	2105	4210	2005	2005	3990	3990	211	0.105		138	0.069	
	E	↙	5	B	3.5	0	25	0	100%	100%	2105	0	1985	1985	0	0	209	0.105	0.105	137	0.069	0.069
Tsing Yi Road West	N	↙	1	C	3.6	20	0	1	100%	100%	1975	4090	1835	1835	3950	3950	375	0.204	0.204	320	0.174	0.174
	N	↑	1	C	3.6	0	0	0	0%	0%	2115	0	2115	2115	0	0	310	0.147		275	0.130	
Pedestrian crossing		↔	5P	C	green time = 11s																	
		↑↓	6P	C	green time = 18s																	
		↔	7P	A	green time = 14s																	
		↑↓	8P	B	green time = 15s																	

Notes:		<table border="1"> <tr> <th colspan="2">A.M. Check Phase</th> <th colspan="2">P.M. Check Phase</th> </tr> <tr> <td>εy</td> <td>0.414</td> <td>εy</td> <td>0.324</td> </tr> <tr> <td>L (sec)</td> <td>12</td> <td>L (sec)</td> <td>12</td> </tr> <tr> <td>C (sec)</td> <td>90</td> <td>C (sec)</td> <td>90</td> </tr> <tr> <td>y pract.</td> <td>0.780</td> <td>y pract.</td> <td>0.780</td> </tr> <tr> <td>R.C. (%)</td> <td>89%</td> <td>R.C. (%)</td> <td>141%</td> </tr> </table>	A.M. Check Phase		P.M. Check Phase		εy	0.414	εy	0.324	L (sec)	12	L (sec)	12	C (sec)	90	C (sec)	90	y pract.	0.780	y pract.	0.780	R.C. (%)	89%	R.C. (%)	141%
A.M. Check Phase		P.M. Check Phase																								
εy	0.414	εy	0.324																							
L (sec)	12	L (sec)	12																							
C (sec)	90	C (sec)	90																							
y pract.	0.780	y pract.	0.780																							
R.C. (%)	89%	R.C. (%)	141%																							

Stage / Phase Diagrams			
I/G = 5	I/G = 5	I/G = 5	

Junction: (J2) Tsing Hung Road / Tsing Yi Road																						
Description: 2024 Observed Traffic Flow																						
Approach	Direction	Movement notation	Phase	Stage	Width (m)	Radius (m)		Nearside 0/1	Pro. Turning (%)		Saturation Flow (pcu/hr)	Total Saturation Flow (pcu/hr)	Revised Saturation Flow (pcu/hr)		Total Revised Saturation Flow (pcu/hr)		AM Peak			PM Peak		
						Left	Right		AM	PM			AM	PM	AM	PM	AM	PM	Flow (pcu/hr)	y Value	Critical y	Flow (pcu/hr)
Tsing Yi Road	S	↓	2	A	3.0	0.0	0	1	0%	0%	1915	4030	1915	1915	4030	4030	356	0.186	0.186	257	0.134	0.185
	S	↓	3	A	3.6	0.0	0	0	0%	0%	2115	0	2115	2115	0	0	394	0.186		283	0.134	
	S	←	2	A	3.6	0.0	18	0	100%	100%	2115	2115	1950	1950	1950	1950	350	0.179		360	0.185	
Tsing Yi Road	N	↑	5	C	4.0	30.0	0	1	100%	100%	2015	2015	1920	1920	1920	1920	55	0.029		50	0.026	
	N	↑	4	C	3.7	0.0	0	0	0%	0%	2125	4240	2125	2125	4240	4240	316	0.149	0.149	258	0.121	0.121
	N	↑	5	C	3.6	0.0	0	0	0%	0%	2115	0	2115	2115	0	0	314	0.149		257	0.121	
Tsing Hung Road	E	→	1	A,B	3.3	25.0	0	1	100%	100%	1945	1945	1835	1835	1835	1835	500	0.272		325	0.177	
	E	→	3	B	4.0	0.0	22	0	100%	100%	2155	2155	2015	2015	2015	2015	45	0.022		30	0.015	
Pedestrian Crossing				6P	A,B																	
				7P	C																	
				8P	C																	

Notes:	Traffic Flow (pcu / hr)	Weekday AM Peak	AM Peak Check Phase	PM Peak Check Phase
			Ey 0.335 L (sec) 18 C (sec) 71 y pract. 0.672 R.C. (%) 101%	Ey 0.306 L (sec) 18 C (sec) 71 y pract. 0.672 R.C. (%) 119%

Stage / Phase Diagrams				
I/G = 5	I/G = 5	I/G = 5		

Junction: **(J4) Sai Tso Wan Road / Tsing Yi Road West / Tsing Yi Road**
 Description: **2024 Observed Traffic Flow**

Approach	Direction	Movement notation	Phase	Stage	Width (m)	Radius (m)		Nearside 0/1	Pro. Turning (%)		Saturation Flow (pcu/hr)	Total Saturation Flow (pcu/hr)	Revised Saturation Flow (pcu/hr)		A.M. Peak			P.M. Peak		
						Left	Right		A.M.	P.M.			A.M.	P.M.	Flow (pcu/hr)	y Value	Critical y	Flow (pcu/hr)	y Value	Critical y
Tsing Yi Road	NE	↙	1	A	4.5	15	0	1	100%	100%	2065	2065	1875	1875	260	0.139	0.139	220	0.117	0.117
	NE	↘	1	A	3.4	0	0	0	0%	0%	2095	2095	2095	2095	220	0.105		210	0.100	
Sai Tso Wan Road	NW	↖	3	C,D	3.8	15	0	1	100%	100%	1995	1995	1815	1815	460	0.253		390	0.215	
	NW	↗	4	D	3.8	0	25	0	100%	100%	2135	2135	2015	2015	215	0.107	0.107	180	0.089	0.089
Tsing Yi Road West	SE	↘	2	B,C	3.4	0	0	1	0%	0%	1955	1955	1955	1955	225	0.115		140	0.072	
	SE	↙	2	B,C	3.7	0	25	0	100%	100%	2125	2125	2005	2005	510	0.254	0.254	245	0.122	0.122
Pedestrian crossing		↕	5p	A,B																
		↕	6p	D																
		↕	7p	B,C																
		↕	8p	A,D																

Notes:	<p>Traffic Flow (pcu / hr)</p>	<p>A.M. Check Phase</p> <p>εy 0.500</p> <p>L (sec) 12</p> <p>C (sec) 120</p> <p>y pract. 0.810</p> <p>R.C. (%) 62%</p>	<p>P.M. Check Phase</p> <p>εy 0.329</p> <p>L (sec) 12</p> <p>C (sec) 120</p> <p>y pract. 0.810</p> <p>R.C. (%) 146%</p>
--------	--------------------------------	---	--

Stage / Phase Diagrams			
<p>A</p>	<p>B</p>	<p>C</p>	<p>D</p>
I/G = 5	I/G = 5		I/G = 5
I/G = 5	I/G = 5		I/G = 5

TRAFFIC SIGNALS CALCULATION

Job No: 24001HK

CTA Consultants Ltd.

Junction: (J5) VEC Access / Sai Tso Wan Road
 Description: 2024 Observed Traffic Flow

Approach	Direction	Movement notation	Phase	Stage	Width (m)	Radius (m)		Nearside 0/1	Pro. Turning (%)		Saturation Flow (pcu/hr)	Total Saturation Flow (pcu/hr)	Revised Saturation Flow (pcu/hr)		Total Revised Saturation Flow (pcu/hr)		AM Peak			PM Peak			
						Left	Right		AM	PM			AM	PM	AM	PM	Flow (pcu/hr)	y Value	Critical y	Flow (pcu/hr)	y Value	Critical y	
Sai Tso Wan Road	EB	→	1	A	4.0	0.0	0	1	0%	0%	2015	2015	2015	2015	2015	2015	565	0.280	0.280	465	0.231	0.231	
Sai Tso Wan Road	WB	↖	3	B	4.0	0.0	10	0	100%	100%	2155	2155	1875	1875	1875	1875	145	0.077	0.077	35	0.019	0.019	
	WB	←	2	A.B	4.0	0.0	0	1	0%	0%	2015	2015	2015	2015	2015	2015	530	0.263		640	0.318		
Pedestrian Crossing		↕	4P	C																			
												Min. green time = 7FGm + 5 FGm = 12s											

Notes: (None)	Traffic Flow (pcu / hr)	AM (PM) Peak	AM Peak Check Phase	PM Peak Check Phase
		565(465) → ↖ 145(35) ← 530(640)	E _y 0.358 L (sec) 26 C (sec) 100 y pract. 0.666 R.C. (%) 86%	E _y 0.249 L (sec) 26 C (sec) 100 y pract. 0.666 R.C. (%) 167%

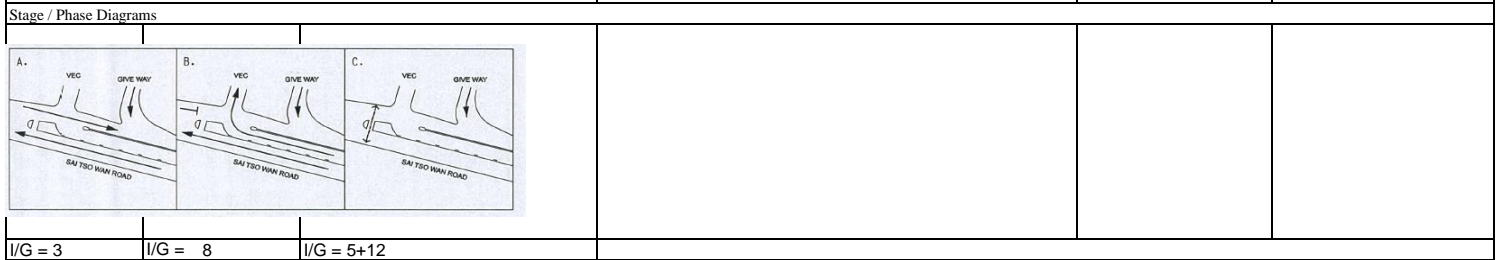

I/G = 3	I/G = 8	I/G = 5+12
---------	---------	------------

TRAFFIC SIGNALS CALCULATION

Job No: 24001HK

CTA Consultants Ltd.

Junction: **(J8) Tsing Yi Road / Tsing Hung Road**
 Description: **2024 Observed Traffic Flow**

Approach	Direction	Movement notation	Phase	Stage	Width (m)	Radius (m)		Nearside 0/1	Pro. Turning (%)		Saturation Flow (pcu/hr)	Total Saturation Flow (pcu/hr)	Revised Saturation Flow (pcu/hr)		Total Revised Saturation Flow (pcu/hr)		AM Peak			PM Peak		
						Left	Right		AM	PM			AM	PM	AM	PM	Flow (pcu/hr)	y Value	Critical y	Flow (pcu/hr)	y Value	Critical y
						Tsing Yi Road West	S		↓	1			A	3.0	0.0	0	0	0%	0%	2055	4160	2055
	S	↓	1	A	3.5	0.0	0	0	0%	0%	2105	0	2105	2105	0	0	185	0.088		124	0.059	
	S	↘	1	A	3.7	10.0	0	1	100%	100%	1985	1985	1725	1725	1725	1725	300	0.174		185	0.107	
Tsing Yi Road West	N	↑	2	A,B	3.5	0.0	0	1	0%	0%	1965	4070	1965	1965	4070	4070	179	0.091		200	0.102	
	N	↑	2	A,B	3.5	0.0	0	0	0%	0%	2105	0	2105	2105	0	0	191	0.091		215	0.102	
	N	↗	3	B	3.3	0.0	18	0	100%	100%	2085	2085	1925	1925	1925	1925	275	0.143	0.143	255	0.132	0.132
Ching Hong Road	W	↔	4	C	3.4	18.0	20	0	16% / 84%	15% / 85%	2095	0	1945	1945	0	0	280	0.144	0.144	248	0.128	0.128
	W	√	4	C	3.4	15.0	0	1	100%	100%	1955	4050	1775	1775	3720	3720	255	0.144		227	0.128	
Pedestrian crossing		↕	5P	A,B					Min. Green time = 11s (G) + 8s (FS) = 19s													
		↕	5P	C					Min. Green time = 5s (G) + 12s (FS) = 17s													
Pedestrian Crossing																						

Notes:	Traffic Flow (pcu / hr) Weekday AM Peak 365(245) 300(185) 370(415) 275(255) 235(210) 300(265)	AM Peak Check Phase E _y 0.461 L (sec) 14 C (sec) 100 y pract. 0.774 R.C. (%) 68%	PM Peak Check Phase E _y 0.367 L (sec) 14 C (sec) 100 y pract. 0.774 R.C. (%) 111%
--------	--	--	---

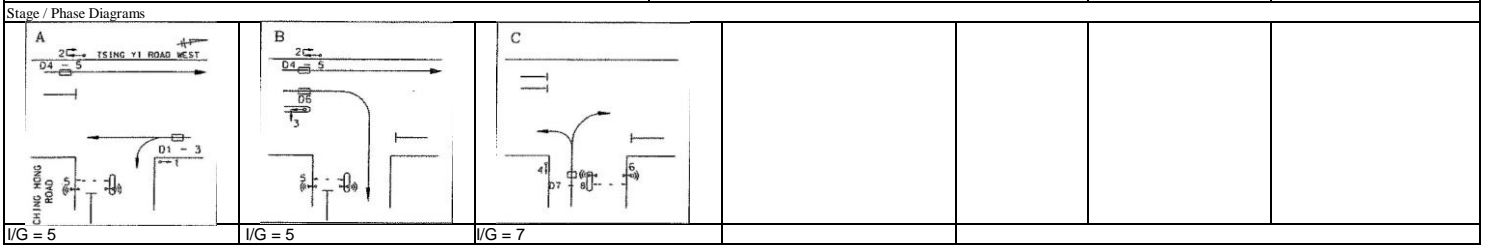

Junction: (J9) Tsing Yi Road West / Liu To Road
 Description: 2024 Observed Traffic Flow

Approach	Direction	Movement notation	Phase	Stage	Width (m)	Radius (m)		Nearside 0/1	Pro. Turning (%)		Saturation Flow (pcu/hr)	Total Saturation Flow (pcu/hr)	Revised Saturation Flow (pcu/hr)		Total Revised Saturation Flow (pcu/hr)		AM Peak			PM Peak		
						Left	Right		AM	PM			AM	PM	AM	PM	Flow (pcu/hr)	y Value	Critical y	Flow (pcu/hr)	y Value	Critical y
						Tsing Yi Road West	S		↓	2			A,B	3.3	0.0	0	1	0%	0%	1945	4030	1945
	S	↓	2	A,B	3.3	0.0	0	0	0%	0%	2085	0	2085	2085	0	0	217	0.104		184	0.088	
	S	↙	3	B	3.3	0.0	22	0	100%	100%	2085	2085	1950	1950	1950	1950	295	0.151	0.151	320	0.164	0.164
Tsing Yi Road West	N	↗	1	A	3.2	10.0	0	1	51%	38%	1935	4100	1795	1830	3960	3995	274	0.153	0.153	286	0.156	0.156
	N	↑	1	A	4.1	0.0	0	0	0%	0%	2165	0	2165	2165	0	0	331	0.153		339	0.156	
Liu To Road	E	↖	5	B,C	3.2	10.0	0	1	100%	100%	1935	1935	1685	1685	1685	1685	390	0.231		280	0.166	
	E	↓	4	C	4.1	0.0	18	0	100%	100%	2165	2165	2000	2000	2000	2000	240	0.120	0.120	75	0.038	0.038
Pedestrian crossing		↕	6P	A,D					Min. Green time = 5s (G) + 9s (FS) = 14s													
		↕	7P	C,D					Min. Green time = 5s (G) + 13s (FS) = 18s													
		↔	8P	D					Min. Green time = 5s (G) + 8s (FS) = 13s													

Notes:	Traffic Flow (pcu / hr) Weekday AM Peak 390(280) 240(75) 295(320) 420(355) 140(110) 465(515)	AM Peak Check Phase E _y 0.424 L (sec) 38 C (sec) 110 y pract. 0.589 R.C. (%) 39%	PM Peak Check Phase E _y 0.358 L (sec) 38 C (sec) 100 y pract. 0.558 R.C. (%) 56%
--------	---	--	--

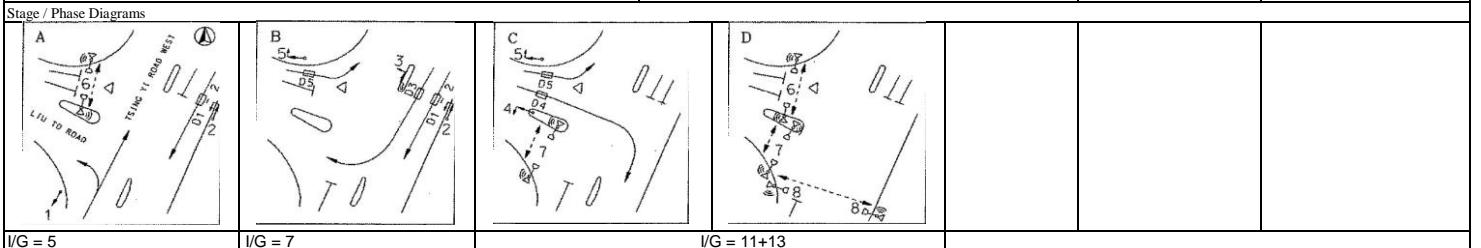

Junction: (J10) Tsing Yi Road West / Fung Shue Wo Road
 Description: 2024 Observed Traffic Flow

Approach	Direction	Movement notation	Phase	Stage	Width (m)	Radius (m)		Nearside 0/1	Pro. Turning (%)		Saturation Flow (pcu/hr)	Total Saturation Flow (pcu/hr)	Revised Saturation Flow (pcu/hr)		Total Revised Saturation Flow (pcu/hr)		AM Peak			PM Peak		
						Left	Right		AM	PM			AM	PM	AM	PM	Flow (pcu/hr)	y Value	Critical y	Flow (pcu/hr)	y Value	Critical y
Fung Shue Wo Road	S	↓	1	A,D	4.1	0.0	0	0	0%	0%	2165	4310	2165	2165	4310	4310	289	0.133	0.133	266	0.123	0.123
(To Tsing Yi Road West)	S	↓	1	A,D	3.9	0.0	0	0	0%	0%	2145	0	2145	2145	0	0	286	0.133		264	0.123	
Fung Shue Wo Road	S	↓	1	A,D	4.0	0.0	0	1	0%	0%	2015	4170	2015	2015	4170	4170	259	0.128		215	0.107	
(To Fung Shue Wo Road)	S	↓	1	A,D	4.0	0.0	0	0	0%	0%	2155	0	2155	2155	0	0	276	0.128		230	0.107	
Tsing Yi Road West	N	↑	2	A,B	3.5	0.0	0	1	0%	0%	1965	4070	1965	1965	4070	4070	314	0.160		316	0.161	
	N	↑	2	A,B	3.5	0.0	0	0	0%	0%	2105	0	2105	2105	0	0	336	0.160		339	0.161	
	N	↗	3	B	3.6	0.0	18	0	100%	100%	2115	2115	1950	1950	1950	1950	210	0.108	0.108	140	0.072	0.072
Fung Shue Wo Road	N	↖	4	C	3.8	35.0	0	1	100%	100%	1995	4150	1915	1915	3990	3990	70	0.036		67	0.035	
	N	↖	4	C	4.0	38.0	0	0	100%	100%	2155	0	2075	2075	0	0	75	0.036		73	0.035	
Fung Shue Wo Road	N	↗	4	C	3.6	0.0	43	0	100%	100%	2115	4230	2045	2045	4085	4085	258	0.126	0.126	213	0.104	0.104
	N	↗	4	C	3.6	0.0	40	0	100%	100%	2115	0	2040	2040	0	0	257	0.126		212	0.104	
Pedestrian crossing		←---→	5p	D																		
		←---→	6P	B,C																		
		↑	7P	A,C,D																		
		↓	8P	A,B,D																		

Notes:	Traffic Flow (pcu / hr)	Weekday AM Peak	AM Peak Check Phase	PM Peak Check Phase
		575(530) 535(445)	εy 0.367	εy 0.299
		↑ ↗	L (sec) 12	L (sec) 12
		↓ ↖	C (sec) 100	C (sec) 100
		↖ ↗	y pract. 0.792	y pract. 0.792
		650(655) 210(140) 145(140) 515(425)	R.C. (%) 116%	R.C. (%) 165%

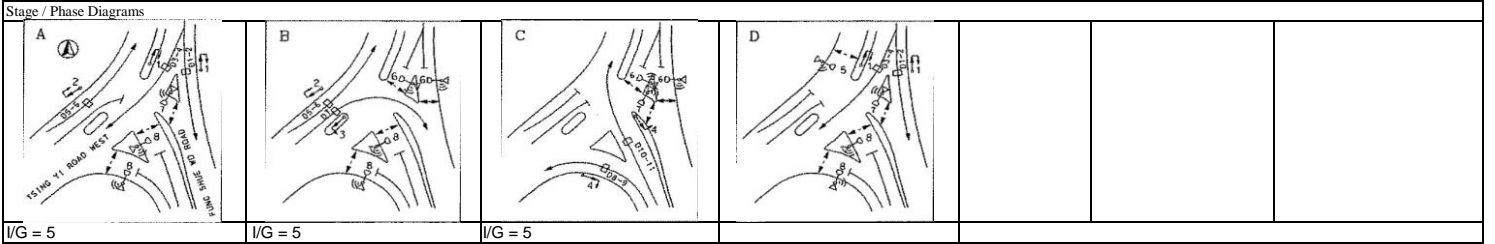

Junction: **(J1) Cheung Tsing Highway / Tsing Yi Road West**
 Description: **2024 Observed Traffic Flow**

Approach	Direction	Movement notation	Phase	Stage	Width (m)	Radius (m)		Nearside 0/1	Pro. Turning (%)		Saturation Flow (pcu/hr)	Total Saturation Flow (pcu/hr)	Revised Saturation Flow (pcu/hr)		Total Revised Saturation Flow (pcu/hr)		Logistic Peak		
						Left	Right		Logistic Peak				Logistic Peak		Logistic Peak		Flow (pcu/hr)	y Value	Critical y
Tsing Yi Road West	S	↕	2	A	3.5	0	0	0	0%		2105	6135	2105		5900		159	0.075	0.075
	S	↙	2	A	3.3	0	20	0	53%		2085	0	2005		0		151	0.075	
	S	↘	2	A	3.3	0	17.5	1	100%		1945	0	1790		0		135	0.075	
Cheung Tsing Highway	E	→	3	A,B	3.4	20	0	1	100%		1955	1955	1820		1820		300	0.165	
	E	↘	4	B	3.5	0	30	0	100%		2105	4070	2005		3860		244	0.122	
	E	↙	4	B	3.5	0	25	1	100%		1965	0	1855		0		226	0.122	0.122
Tsing Yi Road West	N	↙	1	C	3.6	20	0	1	100%		1975	4090	1835		3950		455	0.248	0.248
	N	↘	1	C	3.6	0	0	0	0%		2115	0	2115		0		310	0.147	
Pedestrian crossing		↔	5P	C															
		↕	6P	C															
		↔	7P	A															
		↕	8P	B															

Notes:	Traffic Flow (pcu / hr)	Logistic Check Phase
		εy 0.445 L (sec) 12 C (sec) 90 y pract. 0.780 R.C. (%) 75%

Stage / Phase Diagrams		
A 	B 	C
I/G = 5	I/G = 5	I/G = 5
I/G = 5	I/G = 5	I/G = 5

Junction: J2 - Tsing Hung Road / Tsing Yi Road																					
Description: 2024 Observed Traffic Flow																					
Approach	Direction	Movement notation	Phase	Stage	Width (m)	Radius (m)		Nearside 0/1	Pro. Turning (%)		Saturation Flow (pcu/hr)	Total Saturation Flow (pcu/hr)	Revised Saturation Flow (pcu/hr)		Total Revised Saturation Flow (pcu/hr)			Logistic Peak			
						Left	Right		Logistic Peak				Logistic Peak		Logistic Peak		Flow (pcu/hr)	y Value	Critical y	Flow (pcu/hr)	y Value
Tsing Yi Road	S	↓	2	A	3.0	0.0	0	1	0%		1915	4030	1915		4030	316	0.165	0.165			
	S	↓	3	A	3.6	0.0	0	0	0%		2115	0	2115		0	349	0.165				
	S	←	2	A	3.6	0.0	18	0	100%		2115	2115	1950		1950	305	0.156				
Tsing Yi Road	N	↑	5	C	4.0	30.0	0	1	100%		2015	2015	1920		1920	55	0.029				
	N	↑	4	C	3.7	0.0	0	0	0%		2125	4240	2125		4240	333	0.157	0.157			
	N	↑	5	C	3.6	0.0	0	0	0%		2115	0	2115		0	332	0.157				
Tsing Hung Road	E	→	1	A,B	3.3	25.0	0	1	100%		1945	1945	1835		1835	300	0.163				
	E	→	3	B	4.0	0.0	22	0	100%		2155	2155	2015		2015	45	0.022				
Pedestrian Crossing			6P	A,B																	
			7P	C																	
			8P	C																	
Notes:											Traffic Flow (pcu / hr) Weekday AM Peak 					Logistic Peak Check Phase Ey 0.322 L (sec) 18 C (sec) 71 y pract. 0.672 R.C. (%) 109%					
Stage / Phase Diagrams																					
I/G = 5			I/G = 5			I/G = 5															

Junction: **(J4) Sai Tso Wan Road / Tsing Yi Road West / Tsing Yi Road**
 Description: **2024 Observed Traffic Flow**

Approach	Direction	Movement notation	Phase	Stage	Width (m)	Radius (m)		Nearside 0/1	Pro. Turning (%)		Saturation Flow (pcu/hr)	Total Saturation Flow (pcu/hr)	Revised Saturation Flow (pcu/hr)		Logistic Peak				
						Left	Right		Logistic Peak				Logistic Peak		Flow (pcu/hr)	y Value	Critical y	Flow (pcu/hr)	y Value
Tsing Yi Road	NE		1	A	4.5	15	0	1	100%		2065	2065	1875	260	0.139	0.139			
	NE		1	A	3.4	0	0	0	0%		2095	2095	2095	250	0.119				
Sai Tso Wan Road	NW		3	C,D	3.8	15	0	1	100%		1995	1995	1815	560	0.309				
	NW		4	D	3.8	0	25	0	100%		2135	2135	2015	305	0.151	0.151			
Tsing Yi Road West	SE		2	B,C	3.4	0	0	1	0%		1955	1955	1955	205	0.105				
	SE		2	B,C	3.7	0	25	0	100%		2125	2125	2005	480	0.239	0.239			
Pedestrian crossing			5p	A,B	Green time = 5GM + 7FG = 12s														
			6p	D	Green time = 5GM + 9FG = 14s														
			7p	B,C	Green time = 5GM + 7FG = 12s														
			8p	A,D	Green time = 5GM + 7FG = 12s														

Notes:	<p>Traffic Flow (pcu / hr)</p>	<p>Logistic Peak Check Phase</p> <p>εy 0.529 L (sec) 12 C (sec) 71 y pract. 0.748 R.C. (%) 41%</p>
--------	--------------------------------	--

Stage / Phase Diagrams

<p>I/G = 5</p>	<p>I/G = 5</p>	<p>I/G = 2</p>	<p>I/G = 5</p>
I/G = 5	I/G = 8+12	I/G = 2	

TRAFFIC SIGNALS CALCULATION

Job No: 24001HK

CTA Consultants Ltd.

Junction: (J5) VEC Access / Sai Tso Wan Road
 Description: 2024 Observed Traffic Flow

Approach	Direction	Movement notation	Phase	Stage	Radius (m)		Nearside 0/1	Pro. Turning (%)		Saturation Flow (pcu/hr)	Total Saturation Flow (pcu/hr)	Revised Saturation Flow (pcu/hr)		Total Revised Saturation Flow (pcu/hr)		Logistic Peak		
					Left	Right		Logistic Peak				Logistic Peak		Logistic Peak		Flow (pcu/hr)	y Value	Critical y
Sai Tso Wan Road	EB	→	1	A	4.0	0.0	0	1	0%	2015	2015	2015		2015		740	0.367	0.367
Sai Tso Wan Road	WB	↑	3	B	4.0	0.0	10	0	100%	2155	2155	1875		1875		125	0.067	0.067
	WB	←	2	A.B	4.0	0.0	0	1	0%	2015	2015	2015		2015		550	0.273	
Pedestrian Crossing		↕	4P	C														Min. green time = 7FGm + 5 FGm = 12s

Notes: (None)	Traffic Flow (pcu / hr) AM (PM) Peak 740 → ↑ 125 ← 550	Logistic Peak Check Phase Ey 0.434 L (sec) 26 C (sec) 100 y pract. 0.666 R.C. (%) 53%
------------------	---	--

Stage / Phase Diagrams		
I/G = 3	I/G = 8	I/G = 5+12

TRAFFIC SIGNALS CALCULATION

Job No: 24001HK

CTA Consultants Ltd.

Junction: **J8 - Tsing Yi Road / Tsing Hung Road**
 Description: **2024 Observed Traffic Flow**

Approach	Direction	Movement notation	Phase	Stage	Width (m)			Radius (m)		Nearside 0/1	Pro. Turning (%)		Saturation Flow (pcu/hr)	Total Saturation Flow (pcu/hr)	Revised Saturation Flow (pcu/hr)		Total Revised Saturation Flow (pcu/hr)		Logistic Peak		
					Left	Right		Left	Right		Logistic Peak				Logistic Peak		Flow (pcu/hr)	y Value	Critical y	Flow (pcu/hr)	y Value
Tsing Yi Road West	S	↓	1	A	3.0	0.0	0	0	0	0	0%	2055	4160	2055	4160	148	0.072	0.104			
	S	↓	1	A	3.5	0.0	0	0	0	0%	2105	0	2105	0	152	0.072					
	S	↘	1	A	3.7	10.0	0	1	100%	1985	1985	1725	1725	180	0.104						
Tsing Yi Road West	N	↑	2	A,B	3.5	0.0	0	1	0%	1965	4070	1965	4070	191	0.097						
	N	↑	2	A,B	3.5	0.0	0	0	0%	2105	0	2105	0	204	0.097						
	N	↗	3	B	3.3	0.0	18	0	100%	2085	2085	1925	1925	300	0.156	0.156					
Ching Hong Road	W	↔	4	C	3.4	18.0	20	0	19% / 81%	2095	0	1945	0	246	0.126	0.126					
	W	↙	4	C	3.4	15.0	0	1	100%	1955	4050	1775	3720	224	0.126						
Pedestrian crossing		↕	5P	A,B																	
		↕	5P	C																	
Pedestrian Crossing																					

Notes:	Traffic Flow (pcu / hr) Weekday AM Peak 	Logistic Peak Check Phase E _y 0.387 L (sec) 12 C (sec) 71 y pract. 0.748 R.C. (%) 93%
--------	---	---

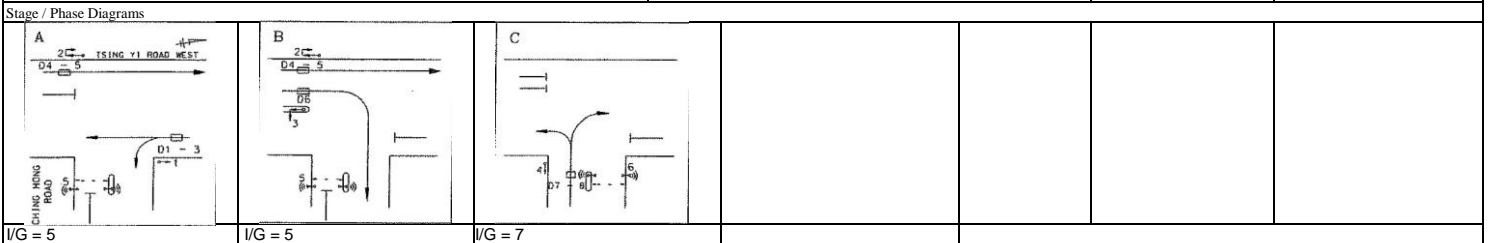

Junction: **J9 - Tsing Yi Road West / Liu To Road**
 Description: **2024 Observed Traffic Flow**

Approach	Direction	Movement notation	Phase	Stage	Width (m)	Radius (m)		Nearside 0/1	Pro. Turning (%)		Saturation Flow (pcu/hr)	Total Saturation Flow (pcu/hr)	Revised Saturation Flow (pcu/hr)		Total Revised Saturation Flow (pcu/hr)			Logistic Peak					
						Left	Right		Logistic Peak				Logistic Peak		Logistic Peak		Flow (pcu/hr)	y Value	Critical y	Flow (pcu/hr)	y Value	Critical y	
Tsing Yi Road West	S	↓	2	A,B	3.3	0.0	0	1	0%		1945	4030	1945	4030	198	0.102							
	S	↓	2	A,B	3.3	0.0	0	0	0%		2085	0	2085	0	212	0.102							
	S	↙	3	B	3.3	0.0	22	0	100%		2085	2085	1950	1950	340	0.174	0.174						
Tsing Yi Road West	N	↖	1	A	3.2	10.0	0	1	48%		1935	4100	1805	3970	271	0.150	0.150						
	N	↑	1	A	4.1	0.0	0	0	0%		2165	0	2165	0	324	0.150							
Liu To Road	E	↗	5	B,C	3.2	10.0	0	1	100%		1935	1935	1685	1685	305	0.181							
	E	↘	4	C	4.1	0.0	18	0	100%		2165	2165	2000	2000	65	0.033	0.033						
Pedestrian crossing		↕	6P	A,D					Min. Green time = 5s (G) + 9s (FS) = 14s														
		↕	7P	C,D					Min. Green time = 5s (G) + 13s (FS) = 18s														
		↔	8P	D					Min. Green time = 5s (G) + 8s (FS) = 13s														
Pedestrian Crossing																							

Notes:	Traffic Flow (pcu / hr)	Weekday AM Peak	Logistic Peak Check Phase
	305 65 130		Ey 0.357 L (sec) 38 C (sec) 110 y pract. 0.589 R.C. (%) 65%

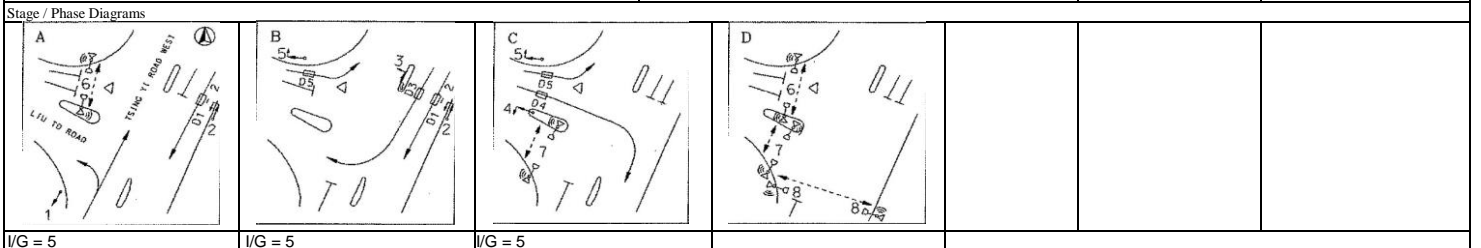

I/G = 5 I/G = 5 I/G = 5

Junction: **J10 - Tsing Yi Road West / Fung Shue Wo Road**
 Description: **2024 Observed Traffic Flow**

Approach	Direction	Movement notation	Phase	Stage	Width (m)	Radius (m)		Nearside 0/1	Pro. Turning (%)		Saturation Flow (pcu/hr)	Total Saturation Flow (pcu/hr)	Revised Saturation Flow (pcu/hr)		Total Revised Saturation Flow (pcu/hr)		Logistic Peak				
						Left	Right		Logistic Peak				Logistic Peak		Flow (pcu/hr)	y Value	Critical y	Flow (pcu/hr)	y Value	Critical y	
Fung Shue Wo Road	S	↓	1	A,D	4.1	0.0	0	0	0%		2165	4310	2165		4310	314	0.145	0.145			
(To Tsing Yi Road West)	S	↓	1	A,D	3.9	0.0	0	0	0%		2145	0	2145		0	311	0.145				
Fung Shue Wo Road	S	↓	1	A,D	4.0	0.0	0	1	0%		2015	4170	2015		4170	191	0.095				
(To Fung Shue Wo Road)	S	↓	1	A,D	4.0	0.0	0	0	0%		2155	0	2155		0	204	0.095				
Tsing Yi Road West	N	↑	2	A,B	3.5	0.0	0	1	0%		1965	4070	1965		4070	295	0.150				
	N	↑	2	A,B	3.5	0.0	0	0	0%		2105	0	2105		0	315	0.150				
	N	↗	3	B	3.6	0.0	18	0	100%		2115	2115	1950		1950	155	0.079	0.079			
Fung Shue Wo Road	N	↖	4	C	3.8	35.0	0	1	100%		1995	4150	1915		3990	60	0.031				
	N	↖	4	C	4.0	38.0	0	0	100%		2155	0	2075		0	65	0.031				
Fung Shue Wo Road	N	↗	4	C	3.6	0.0	43	0	100%		2115	4230	2045		4085	208	0.102	0.102			
	N	↗	4	C	3.6	0.0	40	0	100%		2115	0	2040		0	207	0.102				
Pedestrian crossing		←---→	5p	D																	
		←---→	6P	B,C																	
		↑	7P	A,C,D																	
		↓	8P	A,B,D																	

Notes:	Traffic Flow (pcu / hr) Weekday AM Peak	Logistic Peak Check Phase
		E _y 0.326 L (sec) 12 C (sec) 100 y pract. 0.792 R.C. (%) 143%

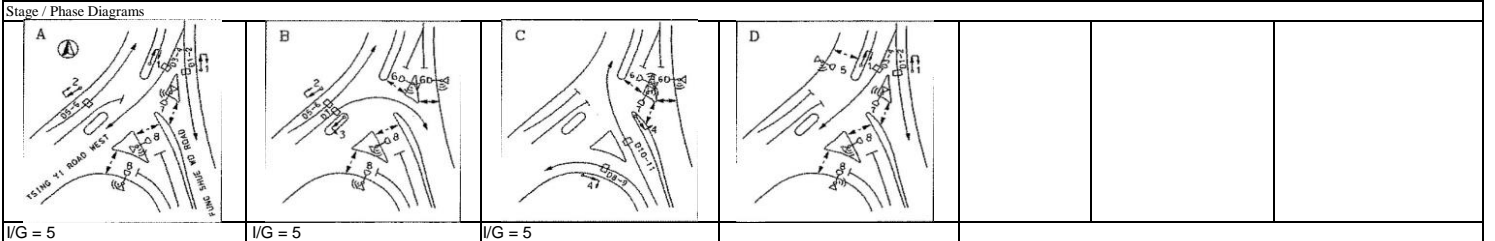

Junction: (J1) Tsing Yi Road West / Cheung Tsing Highway
 Description: 2029 Design Traffic Flow

Approach	Direction	Movement notation	Phase	Stage	Radius (m)		Nearside 0/1	Pro. Turning (%)		Saturation Flow (pcu/hr)	Total Saturation Flow (pcu/hr)	Revised Saturation Flow (pcu/hr)		Total Revised Saturation Flow (pcu/hr)		A.M. Peak			P.M. Peak			
					Left	Right		A.M.	P.M.			A.M.	P.M.	A.M.	P.M.	Flow (pcu/hr)	y Value	Critical y	Flow (pcu/hr)	y Value	Critical y	
																						Width (m)
Tsing Yi Road West	S	↓	2	A	3.5	0	0	0%	0%	2105	6135	2105	2105	5910	5835	242	0.115	0.115	182	0.087	0.087	
	S	↙	2	A	3.3	0	20	0	47%	98%	2085	0	2015	1940	0	0	232	0.115		168	0.087	
	S	↘	3	A	3.3	0	17.5	1	100%	100%	1945	0	1790	1790	0	0	206	0.115		155	0.087	
Cheung Tsing Highway	E	↗	3	A,B	3.4	20	0	1	100%	100%	1955	1955	1820	1820	1820	1820	545	0.299		420	0.231	
	E	↘	4	B	3.5	0	30	0	100%	100%	2105	4210	2005	2005	3990	3990	229	0.114		153	0.076	
	E	↙	5	B	3.5	0	25	0	100%	100%	2105	0	1985	1985	0	0	226	0.114	0.114	152	0.076	0.076
Tsing Yi Road West	N	↖	1	C	3.6	20	0	1	100%	100%	1975	4090	1835	1835	3950	3950	410	0.223	0.223	350	0.191	0.191
	N	↑	1	C	3.6	0	0	0	0%	0%	2115	0	2115	2115	0	0	335	0.158		300	0.142	
Pedestrian crossing		↔	5P	C	green time = 11s																	
		↕	6P	C	green time = 18s																	
		↔	7P	A	green time = 14s																	
		↕	8P	B	green time = 15s																	

Notes:	Traffic Flow (pcu / hr)	A.M. Check Phase	P.M. Check Phase
		εy 0.453 L (sec) 12 C (sec) 90 y pract. 0.780 R.C. (%) 72%	εy 0.354 L (sec) 12 C (sec) 90 y pract. 0.780 R.C. (%) 120%

Stage / Phase Diagrams			
A 	B 	C 	
I/G = 5	I/G = 5	I/G = 5	

Junction: (J2) Tsing Hung Road / Tsing Yi Road																						
Description: 2029 Design Traffic Flow																						
Approach	Direction	Movement notation	Phase	Stage	Width (m)	Radius (m)		Nearside 0/1	Pro. Turning (%)		Saturation Flow (pcu/hr)	Total Saturation Flow (pcu/hr)	Revised Saturation Flow (pcu/hr)		Total Revised Saturation Flow (pcu/hr)		AM Peak			PM Peak		
						Left	Right		AM	PM			AM	PM	AM	PM	AM	PM	Flow (pcu/hr)	y Value	Critical y	Flow (pcu/hr)
Tsing Yi Road	S	↓	2	A	3.0	0.0	0	1	0%	0%	1915	4030	1915	1915	4030	4030	375	0.196	0.196	271	0.141	0.195
	S	↓	3	A	3.6	0.0	0	0	0%	0%	2115	0	2115	2115	0	0	415	0.196		299	0.141	
	S	←	2	A	3.6	0.0	18	0	100%	100%	2115	2115	1950	1950	1950	1950	370	0.190		380	0.195	
Tsing Yi Road	N	↑	5	C	4.0	30.0	0	1	100%	100%	2015	2015	1920	1920	1920	1920	60	0.031		55	0.029	
	N	↑	4	C	3.7	0.0	0	0	0%	0%	2125	4240	2125	2125	4240	4240	331	0.156	0.156	271	0.127	0.127
	N	↑	5	C	3.6	0.0	0	0	0%	0%	2115	0	2115	2115	0	0	329	0.156		269	0.127	
Tsing Hung Road	E	→	1	A,B	3.3	25.0	0	1	100%	100%	1945	1945	1835	1835	1835	1835	525	0.286		340	0.185	
	E	→	3	B	4.0	0.0	22	0	100%	100%	2155	2155	2015	2015	2015	2015	45	0.022		30	0.015	
Pedestrian Crossing				6P	A,B																	
				7P	C																	
				8P	C																	

Notes:	Traffic Flow (pcu / hr)	Weekday AM Peak	AM Peak Check Phase	PM Peak Check Phase
			Ey 0.352 L (sec) 18 C (sec) 71 y pract. 0.672 R.C. (%) 91%	Ey 0.322 L (sec) 18 C (sec) 71 y pract. 0.672 R.C. (%) 108%

Stage / Phase Diagrams				
I/G = 5	I/G = 5	I/G = 5		

Junction: **(J4) Sai Tso Wan Road / Tsing Yi Road West / Tsing Yi Road**
 Description: **2029 Design Traffic Flow**

Approach	Direction	Movement notation	Phase	Stage	Width (m)	Radius (m)		Nearside 0/1	Pro. Turning (%)		Saturation Flow (pcu/hr)	Total Saturation Flow (pcu/hr)	Revised Saturation Flow (pcu/hr)		A.M. Peak			P.M. Peak		
						Left	Right		A.M.	P.M.			A.M.	P.M.	Flow (pcu/hr)	y Value	Critical y	Flow (pcu/hr)	y Value	Critical y
Tsing Yi Road	NE	↙	1	A	4.5	15	0	1	100%	100%	2065	2065	1875	1875	290	0.155	0.155	245	0.131	0.131
	NE	↘	1	A	3.4	0	0	0	0%	0%	2095	2095	2095	2095	230	0.110		220	0.105	
Sai Tso Wan Road	NW	↖	3	C,D	3.8	15	0	1	100%	100%	1995	1995	1815	1815	515	0.284		440	0.242	
	NW	↗	4	D	3.8	0	25	0	100%	100%	2135	2135	2015	2015	240	0.119	0.119	205	0.102	0.102
Tsing Yi Road West	SE	↘	2	B,C	3.4	0	0	1	0%	0%	1955	1955	1955	1955	235	0.120		145	0.074	
	SE	↖	2	B,C	3.7	0	25	0	100%	100%	2125	2125	2005	2005	565	0.282	0.282	285	0.142	0.142
Pedestrian crossing		↕	5p	A,B																
		↔	6p	D																
		↔	7p	B,C																
		↔	8p	A,D																

Notes:	<p>Traffic Flow (pcu / hr)</p>	<p>A.M. Check Phase</p> <p>εy 0.556</p> <p>L (sec) 12</p> <p>C (sec) 120</p> <p>y pract. 0.810</p> <p>R.C. (%) 46%</p>	<p>P.M. Check Phase</p> <p>εy 0.375</p> <p>L (sec) 12</p> <p>C (sec) 120</p> <p>y pract. 0.810</p> <p>R.C. (%) 116%</p>
--------	--------------------------------	---	--

Stage / Phase Diagrams			
<p>A</p>	<p>B</p>	<p>C</p>	<p>D</p>
I/G = 5	I/G = 5		I/G = 5
I/G = 5	I/G = 5		I/G = 5

Junction: (J5) VEC Access / Sai Tso Wan Road
 Description: 2029 Design Traffic Flow

Approach	Direction	Movement notation	Phase	Stage	Width (m)	Radius (m)		Nearside 0/1	Pro. Turning (%)		Saturation Flow (pcu/hr)	Total Saturation Flow (pcu/hr)	Revised Saturation Flow (pcu/hr)		Total Revised Saturation Flow (pcu/hr)		AM Peak			PM Peak		
						Left	Right		AM	PM			AM	PM	AM	PM	Flow (pcu/hr)	y Value	Critical y	Flow (pcu/hr)	y Value	Critical y
Sai Tso Wan Road	EB	→	1	A	4.0	0.0	0	1	0%	0%	2015	2015	2015	2015	2015	2015	640	0.318	0.318	535	0.266	0.266
Sai Tso Wan Road	WB	↑	3	B	4.0	0.0	10	0	100%	100%	2155	2155	1875	1875	1875	1875	150	0.080	0.080	35	0.019	0.019
	WB	←	2	A.B	4.0	0.0	0	1	0%	0%	2015	2015	2015	2015	2015	2015	600	0.298		720	0.357	
Pedestrian Crossing		↕	4P	C																		
Min. green time = 7FGm + 5 FGm = 12s																						

Notes: (None)	Traffic Flow (pcu / hr)	AM (PM) Peak		AM Peak Check Phase			PM Peak Check Phase												
		640(535)	→	150(35)	←	600(720)	εy	0.398	εy	0.284									
				L (sec)	26	L (sec)	26	C (sec)	100	C (sec)	100	y pract.	0.666	y pract.	0.666	R.C. (%)	67%	R.C. (%)	134%

Stage / Phase Diagrams			
I/G = 3	I/G = 8	I/G = 5+12	

Junction: **(J8) Tsing Yi Road / Tsing Hung Road**
 Description: **2029 Design Traffic Flow**

Approach	Direction	Movement notation	Phase	Stage	Width (m)	Radius (m)		Nearside 0/1	Pro. Turning (%)		Saturation Flow (pcu/hr)	Total Saturation Flow (pcu/hr)	Revised Saturation Flow (pcu/hr)		Total Revised Saturation Flow (pcu/hr)		AM Peak			PM Peak			
						Left	Right		AM	PM			AM	PM	AM	PM	Flow (pcu/hr)	y Value	Critical y	Flow (pcu/hr)	y Value	Critical y	
Tsing Yi Road West	S	↓	1	A	3.0	0.0	0	0	0%	0%	2055	4160	2055	2055	4160	4160	198	0.096	0.183	133	0.065	0.113	
	S	↓	1	A	3.5	0.0	0	0	0%	0%	2105	0	2105	2105	0	0	202	0.096		137	0.065		
	S	↘	1	A	3.7	10.0	0	1	100%	100%	1985	1985	1725	1725	1725	1725	315	0.183		195	0.113		
Tsing Yi Road West	N	↑	2	A,B	3.5	0.0	0	1	0%	0%	1965	4070	1965	1965	4070	4070	196	0.100		217	0.111		
	N	↑	2	A,B	3.5	0.0	0	0	0%	0%	2105	0	2105	2105	0	0	209	0.100		233	0.111		
	N	↗	3	B	3.3	0.0	18	0	100%	100%	2085	2085	1925	1925	1925	1925	395	0.205	0.205	330	0.171	0.171	
Ching Hong Road	W	↔	4	C	3.4	18.0	20	0	20% / 80%	19% / 81%	2095	0	1945	1945	0	0	306	0.157	0.157	272	0.140	0.140	
	W	√	4	C	3.4	15.0	0	1	100%	100%	1955	4050	1775	1775	3720	3720	279	0.157		248	0.140		
Pedestrian crossing		↕	5P	A,B																			
		↕	5P	C																			
Pedestrian Crossing																							

Notes:	Traffic Flow (pcu / hr) Weekday AM Peak 405(450) 395(330) 400(270) 315(195)	AM Peak Check Phase E _y 0.545 L (sec) 14 C (sec) 100 y pract. 0.774 R.C. (%) 42%	PM Peak Check Phase E _y 0.424 L (sec) 14 C (sec) 100 y pract. 0.774 R.C. (%) 82%

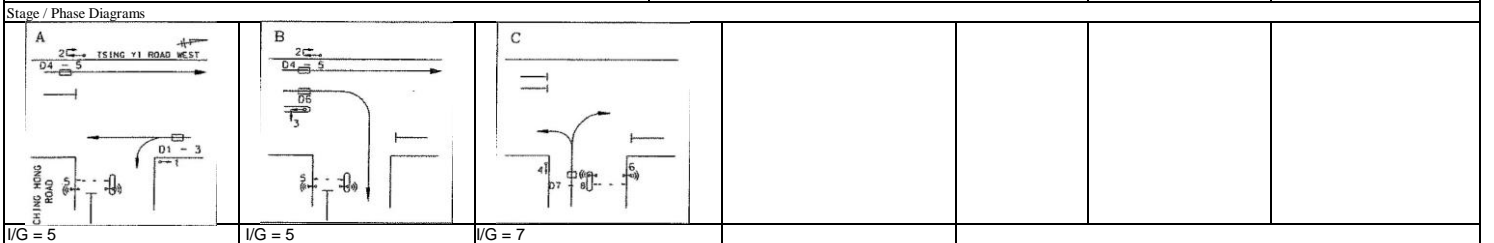

Junction: (J9) Tsing Yi Road West / Liu To Road
 Description: 2029 Design Traffic Flow

Approach	Direction	Movement notation	Phase	Stage	Width (m)	Radius (m)		Nearside 0/1	Pro. Turning (%)		Saturation Flow (pcu/hr)	Total Saturation Flow (pcu/hr)	Revised Saturation Flow (pcu/hr)		Total Revised Saturation Flow (pcu/hr)		AM Peak			PM Peak		
						Left	Right		AM	PM			AM	PM	AM	PM	Flow (pcu/hr)	y Value	Critical y	Flow (pcu/hr)	y Value	Critical y
Tsing Yi Road West	S	↓	2	A,B	3.3	0.0	0	1	0%	0%	1945	4030	1945	1945	4030	4030	220	0.113		188	0.097	
	S	↓	2	A,B	3.3	0.0	0	0	0%	0%	2085	0	2085	2085	0	0	235	0.113		202	0.097	
	S	↙	3	B	3.3	0.0	22	0	100%	100%	2085	2085	1950	1950	1950	1950	310	0.159	0.159	335	0.172	0.172
Tsing Yi Road West	N	↖	1	A	3.2	10.0	0	1	49%	37%	1935	4100	1800	1830	3965	3995	295	0.164	0.164	307	0.168	0.168
	N	↑	1	A	4.1	0.0	0	0	0%	0%	2165	0	2165	2165	0	0	355	0.164		363	0.168	
Liu To Road	E	↗	5	B,C	3.2	10.0	0	1	100%	100%	1935	1935	1685	1685	1685	1685	410	0.243		295	0.175	
	E	↘	4	C	4.1	0.0	18	0	100%	100%	2165	2165	2000	2000	2000	2000	250	0.125	0.125	80	0.040	0.040
Pedestrian crossing		↕	6P	A,D					Min. Green time = 5s (G) + 9s (FS) = 14s													
		↕	7P	C,D					Min. Green time = 5s (G) + 13s (FS) = 18s													
		↔	8P	D					Min. Green time = 5s (G) + 8s (FS) = 13s													
Pedestrian Crossing																						

Notes:	Traffic Flow (pcu / hr) Weekday AM Peak 410(295) 250(80) 310(335) 455(390) 145(115) 505(555)	AM Peak Check Phase		PM Peak Check Phase	
		Ey 0.448 L (sec) 38 C (sec) 110 y pract. 0.589 R.C. (%) 31%	Ey 0.380 L (sec) 38 C (sec) 100 y pract. 0.558 R.C. (%) 47%		

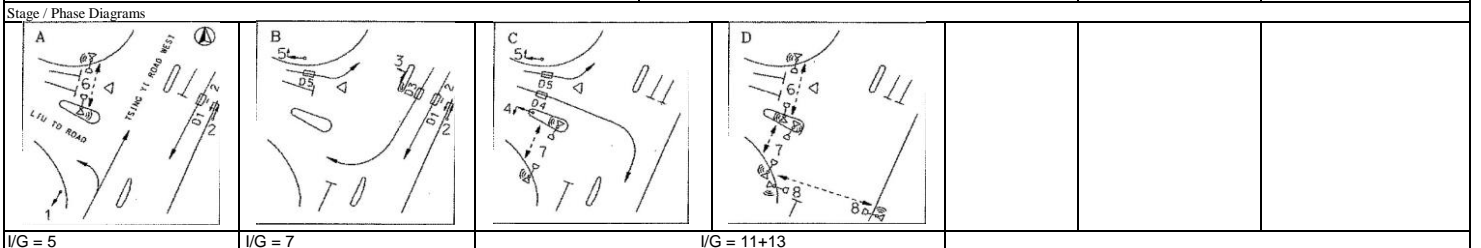

I/G = 5 I/G = 7 I/G = 11+13

Junction: (J10) Tsing Yi Road West / Fung Shue Wo Road
 Description: 2029 Design Traffic Flow

Approach	Direction	Movement notation	Phase	Stage	Width (m)	Radius (m)		Nearside 0/1	Pro. Turning (%)		Saturation Flow (pcu/hr)	Total Saturation Flow (pcu/hr)	Revised Saturation Flow (pcu/hr)		Total Revised Saturation Flow (pcu/hr)		AM Peak			PM Peak		
						Left	Right		AM	PM			AM	PM	AM	PM	Flow (pcu/hr)	y Value	Critical y	Flow (pcu/hr)	y Value	Critical y
Fung Shue Wo Road	S	↓	1	A,D	4.1	0.0	0	0	0%	0%	2165	4310	2165	2165	4310	4310	311	0.144	0.161	286	0.132	0.132
(To Tsing Yi Road West)	S	↓	1	A,D	3.9	0.0	0	0	0%	0%	2145	0	2145	2145	0	0	309	0.144		284	0.132	
Fung Shue Wo Road	S	↓	1	A,D	4.0	0.0	0	1	0%	0%	2015	4170	2015	2015	4170	4170	324	0.161		266	0.132	
(To Fung Shue Wo Road)	S	↓	1	A,D	4.0	0.0	0	0	0%	0%	2155	0	2155	2155	0	0	346	0.161		284	0.132	
Tsing Yi Road West	N	↑	2	A,B	3.5	0.0	0	1	0%	0%	1965	4070	1965	1965	4070	4070	338	0.172		340	0.173	
	N	↑	2	A,B	3.5	0.0	0	0	0%	0%	2105	0	2105	2105	0	0	362	0.172		365	0.173	
	N	↗	3	B	3.6	0.0	18	0	100%	100%	2115	2115	1950	1950	1950	1950	220	0.113	0.113	145	0.074	0.074
Fung Shue Wo Road	N	↖	4	C	3.8	35.0	0	1	100%	100%	1995	4150	1915	1915	3990	3990	72	0.038		70	0.036	
	N	↖	4	C	4.0	38.0	0	0	100%	100%	2155	0	2075	2075	0	0	78	0.038		75	0.036	
Fung Shue Wo Road	N	↗	4	C	3.6	0.0	43	0	100%	100%	2115	4230	2045	2045	4085	4085	323	0.158	0.158	275	0.135	0.135
	N	↗	4	C	3.6	0.0	40	0	100%	100%	2115	0	2040	2040	0	0	322	0.158		275	0.135	
Pedestrian crossing		←---→	5p	D																		
		←---→	6P	B,C																		
		↑	7P	A,C,D																		
		↓	8P	A,B,D																		

Notes:	Traffic Flow (pcu / hr)	Weekday AM Peak	AM Peak Check Phase	PM Peak Check Phase
		620(570) 670(550)	εy 0.431	εy 0.341
		↑ ↗	L (sec) 12	L (sec) 12
		↓ ↖	C (sec) 100	C (sec) 100
		↖ ↗	y pract. 0.792	y pract. 0.792
		700(705) 220(145) 150(145) 645(550)	R.C. (%) 84%	R.C. (%) 132%

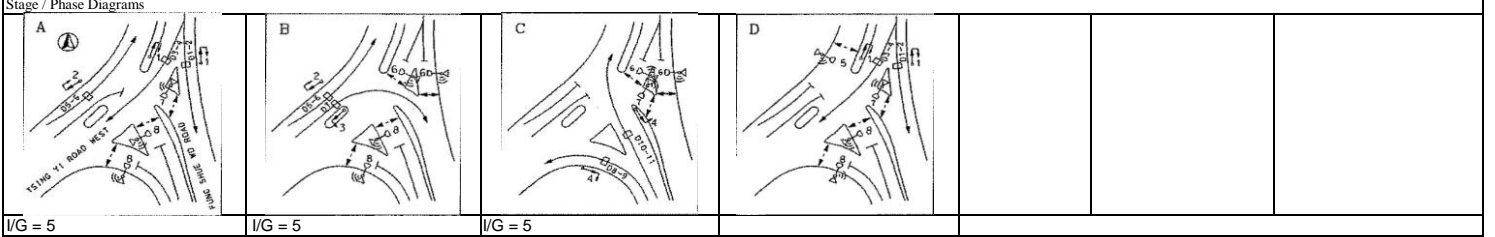

Junction: **(J1) Cheung Tsing Highway / Tsing Yi Road West**
 Description: **2029 Design Traffic Flow**

Approach	Direction	Movement notation	Phase	Stage	Width (m)	Radius (m)		Nearside 0/1	Pro. Turning (%)		Saturation Flow (pcu/hr)	Total Saturation Flow (pcu/hr)	Revised Saturation Flow (pcu/hr)		Total Revised Saturation Flow (pcu/hr)		Logistic Peak		
						Left	Right		Logistic Peak				Logistic Peak		Logistic Peak		Flow (pcu/hr)	y Value	Critical y
Tsing Yi Road West	S	↕	2	A	3.5	0	0	0	0%		2105	6135	2105		5905		178	0.085	0.085
	S	↙	2	A	3.3	0	20	0	49%		2085	0	2010		0		170	0.085	
	S	↘	2	A	3.3	0	17.5	1	100%		1945	0	1790		0		152	0.085	
Cheung Tsing Highway	E	→	3	A,B	3.4	20	0	1	100%		1955	1955	1820		1820		405	0.223	
	E	↘	4	B	3.5	0	30	0	100%		2105	4070	2005		3860		265	0.132	
	E	↙	4	B	3.5	0	25	1	100%		1965	0	1855		0		245	0.132	0.132
Tsing Yi Road West	N	↙	1	C	3.6	20	0	1	100%		1975	4090	1835		3950		495	0.270	0.270
	N	↘	1	C	3.6	0	0	0	0%		2115	0	2115		0		335	0.158	
Pedestrian crossing		↔	5P	C															
		↕	6P	C															
		↔	7P	A															
		↕	8P	B															

Notes:	Traffic Flow (pcu / hr)	Logistic Check Phase
		εy 0.487 L (sec) 12 C (sec) 90 y pract. 0.780 R.C. (%) 60%

Stage / Phase Diagrams		
A 	B 	C
I/G = 5	I/G = 5	I/G = 5
I/G = 5	I/G = 5	I/G = 5

Junction: J2 - Tsing Hung Road / Tsing Yi Road																					
Description: 2029 Design Traffic Flow																					
Approach	Direction	Movement notation	Phase	Stage	Width (m)	Radius (m)		Nearside 0/1	Pro. Turning (%)		Saturation Flow (pcu/hr)	Total Saturation Flow (pcu/hr)	Revised Saturation Flow (pcu/hr)		Total Revised Saturation Flow (pcu/hr)			Logistic Peak			
						Left	Right		Logistic Peak				Logistic Peak		Logistic Peak		Flow (pcu/hr)	y Value	Critical y	Flow (pcu/hr)	y Value
Tsing Yi Road	S	↓	2	A	3.0	0.0	0	1	0%		1915	4030	1915		4030	333	0.174	0.174			
	S	↓	3	A	3.6	0.0	0	0	0%		2115	0	2115		0	367	0.174				
	S	←	2	A	3.6	0.0	18	0	100%		2115	2115	1950		1950	320	0.164				
Tsing Yi Road	N	↑	5	C	4.0	30.0	0	1	100%		2015	2015	1920		1920	60	0.031				
	N	↑	4	C	3.7	0.0	0	0	0%		2125	4240	2125		4240	351	0.165	0.165			
	N	↑	5	C	3.6	0.0	0	0	0%		2115	0	2115		0	349	0.165				
Tsing Hung Road	E	→	1	A,B	3.3	25.0	0	1	100%		1945	1945	1835		1835	315	0.172				
	E	→	3	B	4.0	0.0	22	0	100%		2155	2155	2015		2015	45	0.022				
Pedestrian Crossing			6P	A,B																	
			7P	C																	
			8P	C																	
Notes:											Traffic Flow (pcu / hr) Weekday AM Peak 					Logistic Peak Check Phase Ey 0.339 L (sec) 18 C (sec) 71 y pract. 0.672 R.C. (%) 98%					
Stage / Phase Diagrams																					
I/G = 5			I/G = 5			I/G = 5															

Junction: (J4) Sai Tso Wan Road / Tsing Yi Road West / Tsing Yi Road
 Description: 2029 Design Traffic Flow

Approach	Direction	Movement notation	Phase	Stage	Width (m)	Radius (m)		Nearside 0/1	Pro. Turning (%)		Saturation Flow (pcu/hr)	Total Saturation Flow (pcu/hr)	Revised Saturation Flow (pcu/hr)		Logistic Peak				
						Left	Right		Logistic Peak				Logistic Peak		Flow (pcu/hr)	y Value	Critical y	Flow (pcu/hr)	y Value
Tsing Yi Road	NE		1	A	4.5	15	0	1	100%		2065	2065	1875	290	0.155	0.155			
	NE		1	A	3.4	0	0	0	0%		2095	2095	2095	265	0.126				
Sai Tso Wan Road	NW		3	C,D	3.8	15	0	1	100%		1995	1995	1815	620	0.342				
	NW		4	D	3.8	0	25	0	100%		2135	2135	2015	335	0.166	0.166			
Tsing Yi Road West	SE		2	B,C	3.4	0	0	1	0%		1955	1955	1955	215	0.110				
	SE		2	B,C	3.7	0	25	0	100%		2125	2125	2005	535	0.267	0.267			
Pedestrian crossing			5p	A,B	Green time = 5GM + 7FG = 12s														
			6p	D	Green time = 5GM + 9FG = 14s														
			7p	B,C	Green time = 5GM + 7FG = 12s														
			8p	A,D	Green time = 5GM + 7FG = 12s														

Notes:	<p>Traffic Flow (pcu / hr)</p>	<p>Logistic Peak Check Phase</p> <p>εy 0.588 L (sec) 12 C (sec) 71 y pract. 0.748 R.C. (%) 27%</p>
--------	--------------------------------	--

Stage / Phase Diagrams			
<p>A</p>	<p>B</p>	<p>C</p>	<p>D</p>
I/G = 5	I/G = 5		I/G = 5
I/G = 5	I/G = 8+12	I/G = 2	

TRAFFIC SIGNALS CALCULATION

Job No: 24001HK

CTA Consultants Ltd.

Junction: (J5) VEC Access / Sai Tso Wan Road
 Description: 2029 Design Traffic Flow

Approach	Direction	Movement notation	Phase	Stage	Width (m)	Radius (m)		Nearside 0/1	Pro. Turning (%)		Saturation Flow (pcu/hr)	Total Saturation Flow (pcu/hr)	Revised Saturation Flow (pcu/hr)		Total Revised Saturation Flow (pcu/hr)		Logistic Peak					
						Left	Right		Logistic Peak				Logistic Peak		Logistic Peak		Flow (pcu/hr)	y Value	Critical y	Flow (pcu/hr)	y Value	Critical y
Sai Tso Wan Road	EB	→	1	A	4.0	0.0	0	1	0%		2015	2015	2015		2015		825	0.409	0.409			
Sai Tso Wan Road	WB	↑	3	B	4.0	0.0	10	0	100%		2155	2155	1875		1875		130	0.069	0.069			
	WB	←	2	A.B	4.0	0.0	0	1	0%		2015	2015	2015		2015		625	0.310				
Pedestrian Crossing		↕	4P	C																		
												Min. green time = 7FGm + 5 FGm = 12s										

Notes: (None)	Traffic Flow (pcu / hr) AM (PM) Peak	Logistic Peak Check Phase
	825 → ↑ 130 ← 625	E _y 0.479 L (sec) 26 C (sec) 100 y _{pract.} 0.666 R.C. (%) 39%

Stage / Phase Diagrams		
I/G = 3	I/G = 8	I/G = 5+12

TRAFFIC SIGNALS CALCULATION

Job No: 24001HK

CTA Consultants Ltd.

Junction: **J8 - Tsing Yi Road / Tsing Hung Road**
 Description: **2029 Design Traffic Flow**

Approach	Direction	Movement notation	Phase	Stage	Width (m)			Radius (m)		Nearside 0/1	Pro. Turning (%)		Saturation Flow (pcu/hr)	Total Saturation Flow (pcu/hr)	Revised Saturation Flow (pcu/hr)		Total Revised Saturation Flow (pcu/hr)		Logistic Peak			
					Left	Right		Left	Right		Logistic Peak				Logistic Peak		Flow (pcu/hr)	y Value	Critical y	Flow (pcu/hr)	y Value	Critical y
Tsing Yi Road West	S	↓	1	A	3.0	0.0	0	0	0	0	0%	2055	4160	2055	4160	163	0.079	0.110				
	S	↓	1	A	3.5	0.0	0	0	0	0%	2105	0	2105	0	167	0.079						
	S	↘	1	A	3.7	10.0	0	1	100%	1985	1985	1725	1725	190	0.110							
Tsing Yi Road West	N	↑	2	A,B	3.5	0.0	0	1	0%	1965	4070	1965	4070	208	0.106							
	N	↑	2	A,B	3.5	0.0	0	0	0%	2105	0	2105	0	222	0.106							
	N	↗	3	B	3.3	0.0	18	0	100%	2085	2085	1925	1925	420	0.218	0.218						
Ching Hong Road	W	↔	4	C	3.4	18.0	20	0	23% / 77%	2095	0	1945	0	272	0.140	0.140						
	W	√	4	C	3.4	15.0	0	1	100%	1955	4050	1775	3720	248	0.140							
Pedestrian crossing		↕	5P	A,B	Min. Green time = 11s (G) + 8s (FS) = 19s																	
		↕	5P	C	Min. Green time = 5s (G) + 12s (FS) = 17s																	
Pedestrian Crossing																						

Notes:	Traffic Flow (pcu / hr) Weekday AM Peak 	Logistic Peak Check Phase E _y 0.468 L (sec) 12 C (sec) 71 y pract. 0.748 R.C. (%) 60%

Stage / Phase Diagrams						
<p>I/G = 5</p>	<p>I/G = 5</p>	<p>I/G = 7</p>				

Junction: **J9 - Tsing Yi Road West / Liu To Road**
 Description: **2029 Design Traffic Flow**

Approach	Direction	Movement notation	Phase	Stage	Width (m)	Radius (m)		Nearside 0/1	Pro. Turning (%)		Saturation Flow (pcu/hr)	Total Saturation Flow (pcu/hr)	Revised Saturation Flow (pcu/hr)		Total Revised Saturation Flow (pcu/hr)			Logistic Peak			
						Left	Right		Logistic Peak				Logistic Peak		Logistic Peak		Flow (pcu/hr)	y Value	Critical y	Flow (pcu/hr)	y Value
Tsing Yi Road West	S	↓	2	A,B	3.3	0.0	0	1	0%		1945	4030	1945	4030	215	0.110					
	S	↓	2	A,B	3.3	0.0	0	0	0%		2085	0	2085	0	230	0.110					
	S	↙	3	B	3.3	0.0	22	0	100%		2085	2085	1950	1950	355	0.182	0.182				
Tsing Yi Road West	N	↖	1	A	3.2	10.0	0	1	46%		1935	4100	1810	3975	291	0.161	0.161				
	N	↑	1	A	4.1	0.0	0	0	0%		2165	0	2165	0	349	0.161					
Liu To Road	E	↗	5	B,C	3.2	10.0	0	1	100%		1935	1935	1685	1685	320	0.190					
	E	↘	4	C	4.1	0.0	18	0	100%		2165	2165	2000	2000	70	0.035	0.035				
Pedestrian crossing		↕	6P	A,D																	
		↕	7P	C,D																	
		↔	8P	D																	

Notes:

Traffic Flow (pcu / hr)	Weekday AM Peak	Logistic Peak Check Phase
320 70		Ey 0.378 L (sec) 38 C (sec) 110 y pract. 0.589 R.C. (%) 56%

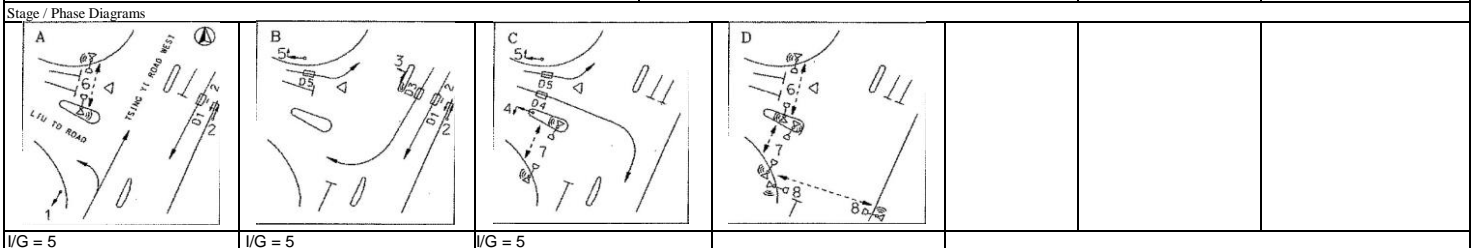

I/G = 5 I/G = 5 I/G = 5

Junction: **J10 - Tsing Yi Road West / Fung Shue Wo Road**
 Description: **2029 Design Traffic Flow**

Approach	Direction	Movement notation	Phase	Stage	Width (m)	Radius (m)		Nearside 0/1	Pro. Turning (%)		Saturation Flow (pcu/hr)	Total Saturation Flow (pcu/hr)	Revised Saturation Flow (pcu/hr)		Total Revised Saturation Flow (pcu/hr)		Logistic Peak				
						Left	Right		Logistic Peak				Logistic Peak		Flow (pcu/hr)	y Value	Critical y	Flow (pcu/hr)	y Value	Critical y	
Fung Shue Wo Road	S	↓	1	A,D	4.1	0.0	0	0	0%		2165	4310	2165		4310	337	0.155	0.155			
(To Tsing Yi Road West)	S	↓	1	A,D	3.9	0.0	0	0	0%		2145	0	2145		0	333	0.155				
Fung Shue Wo Road	S	↓	1	A,D	4.0	0.0	0	1	0%		2015	4170	2015		4170	254	0.126				
(To Fung Shue Wo Road)	S	↓	1	A,D	4.0	0.0	0	0	0%		2155	0	2155		0	271	0.126				
Tsing Yi Road West	N	↑	2	A,B	3.5	0.0	0	1	0%		1965	4070	1965		4070	316	0.161				
	N	↑	2	A,B	3.5	0.0	0	0	0%		2105	0	2105		0	339	0.161				
	N	↗	3	B	3.6	0.0	18	0	100%		2115	2115	1950		1950	165	0.085	0.085			
Fung Shue Wo Road	N	↙	4	C	3.8	35.0	0	1	100%		1995	4150	1915		3990	62	0.033				
	N	↙	4	C	4.0	38.0	0	0	100%		2155	0	2075		0	68	0.033				
Fung Shue Wo Road	N	↗	4	C	3.6	0.0	43	0	100%		2115	4230	2045		4085	270	0.132	0.132			
	N	↗	4	C	3.6	0.0	40	0	100%		2115	0	2040		0	270	0.132				
Pedestrian crossing		←---→	5p	D																	
		←---→	6P	B,C																	
		↑	7P	A,C,D																	
		↓	8P	A,B,D																	

Notes:	Traffic Flow (pcu / hr) Weekday AM Peak 	Logistic Peak Check Phase E _y 0.372 L (sec) 12 C (sec) 100 y pract. 0.792 R.C. (%) 113%
--------	---	---

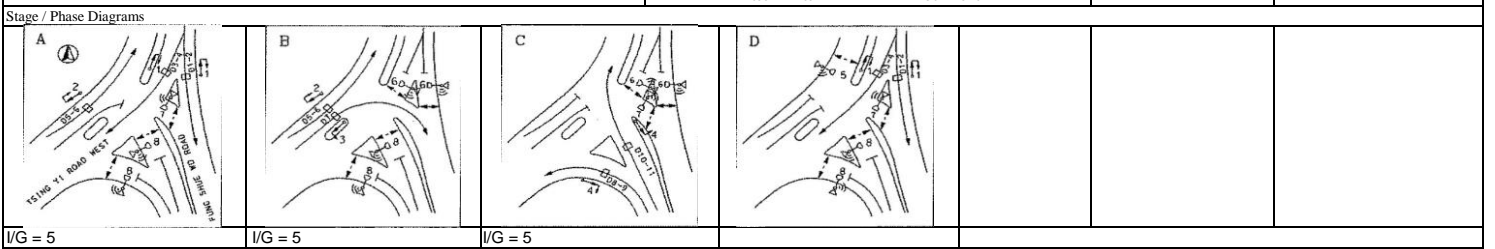

Priority Junction Calculation

Junction : (J3) Tsing Yi Road / Tsing Sheung Road Job No.: 24002HK
 Scenario : 2024 Observed Traffic Flow

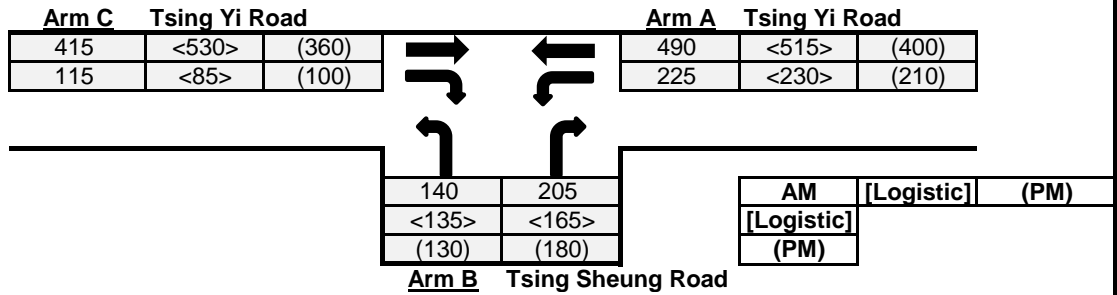

The predictive equations of capacity of movement are:

$$Q-BA = D(627 + 14W-CR - Y(0.364q-AC + 0.144q-AB + 0.229q-CA + 0.52q-CB))$$

$$Q-BC = E(745 - Y(0.364q-AC + 0.144q-AB))$$

$$Q-CB = F(745 - 0.364Y(q-AC + q-AB))$$

The geometric parameters represented by D, E, F are:

$$D = (1 + 0.094(w-BA - 3.65))(1 + 0.0009(V-rBA - 120))(1 + 0.0006(V-IBA - 150))$$

$$E = (1 + 0.094(w-BC - 3.65))(1 + 0.0009(V-rBC - 120))$$

$$F = (1 + 0.094(w-CB - 3.65))(1 + 0.0009(V-rCB - 120))$$

where

- Y = 1 - 0.0345W
- q-AB, etc = the design flow of movement AB, etc
- W = major road width
- W-CR = central reserve width
- w-BA, etc = lane width to vehicle
- v-rBA, etc = visibility to the right for waiting vehicles in stream BA, etc
- v-IBA = visibility to the left for waiting vehicles in stream BA, etc

Geometry :	Input			Calculated			
W	14	V-rBA	50	w-BA	4.5	D	0.951
W-CR	0	V-IBA	50	w-BC	4.5	E	1.012
C-B blocked C-A, residual width <2.5m? (Yes: 1, No: 0)	0	V-rBC	50	w-CB	0	F	0.616
Minor Road Share LT&RT? (Yes: 1, No: 0)	0	V-rCB	50			Y	0.517

Analysis :	Traffic Flow	AM	Logistic	PM	Capacity	AM	Logistic	PM	
	pcu/hr				pcu/hr				
q-CA	415	530	360	Q-BA	417	406	444		
q-CB	115	85	100	Q-BC	644	638	662		
q-AB	225	230	210	Q-CB	376	372	388		
q-AC	490	515	400	Q-CA	N/A	N/A	N/A	(If C-B blocked C-	
q-BA	205	165	180	Q-BAC	N/A	N/A	N/A	(If Minor Road Share	
q-BC	140	135	130					LT&RT)	
f	0.406	0.450	0.419						

Results :	Ratio of Flow-to-Capacity	AM	Logistic	PM
B-A		0.49	0.41	0.41
B-C		0.22	0.21	0.20
C-B		0.31	0.23	0.26
C-A		N/A	N/A	N/A
B-AC		N/A	N/A	N/A

Critical DFC **0.49 0.41 0.41**

Priority Junction Calculation

Junction : (J6) Sai Tso Wan Road / Tsing Tim Street Job No.: 24001HK
 Scenario : 2024 Observed Traffic Flow

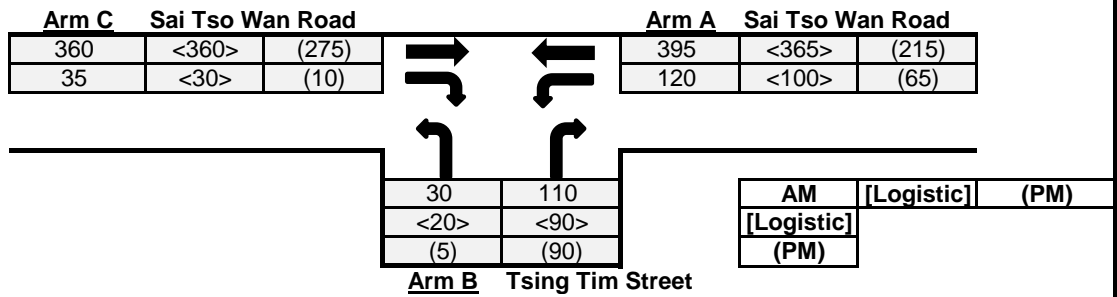

The predictive equations of capacity of movement are:

$$Q-BA = D(627 + 14W-CR - Y(0.364q-AC + 0.144q-AB + 0.229q-CA + 0.52q-CB))$$

$$Q-BC = E(745 - Y(0.364q-AC + 0.144q-AB))$$

$$Q-CB = F(745 - 0.364Y(q-AC + q-AB))$$

The geometric parameters represented by D, E, F are:

$$D = (1 + 0.094(w-BA - 3.65))(1 + 0.0009(V-rBA - 120))(1 + 0.0006(V-IBA - 150))$$

$$E = (1 + 0.094(w-BC - 3.65))(1 + 0.0009(V-rBC - 120))$$

$$F = (1 + 0.094(w-CB - 3.65))(1 + 0.0009(V-rCB - 120))$$

where

- Y = 1 - 0.0345W
- q-AB, etc = the design flow of movement AB, etc
- W = major road width
- W-CR = central reserve width
- w-BA, etc = lane width to vehicle
- v-rBA, etc = visibility to the right for waiting vehicles in stream BA, etc
- v-IBA = visibility to the left for waiting vehicles in stream BA, etc

Geometry :	Input			Calculated			
W	7	V-rBA	50	w-BA	3	D	0.827
W-CR	0	V-IBA	50	w-BC	3	E	0.880
C-B blocked C-A, residual width <2.5m? (Yes: 1, No: 0)	0	V-rBC	50	w-CB	0	F	0.616
Minor Road Share LT&RT? (Yes: 1, No: 0)	0	V-rCB	50			Y	0.759

Analysis :	Traffic Flow	AM	Logistic	PM	Capacity	AM	Logistic	PM	
	pcu/hr				pcu/hr				
q-CA	360	360	275		Q-BA	354	365	421	
q-CB	35	30	10		Q-BC	548	557	597	
q-AB	120	100	65		Q-CB	371	380	411	
q-AC	395	365	215		Q-CA	N/A	N/A	N/A	(If C-B blocked C-
q-BA	110	90	90		Q-BAC	N/A	N/A	N/A	(If Minor Road Share LT&RT)
q-BC	30	20	5						
f	0.214	0.182	0.053						

Results :	Ratio of Flow-to-Capacity	AM	Logistic	PM
B-A		0.31	0.25	0.21
B-C		0.05	0.04	0.01
C-B		0.09	0.08	0.02
C-A		N/A	N/A	N/A
B-AC		N/A	N/A	N/A

Critical DFC **0.31 0.25 0.21**

Priority Junction Calculation

Junction : (J3) Tsing Yi Road / Tsing Sheung Road Job No.: 24002HK
 Scenario : 2029 Design Traffic Flow

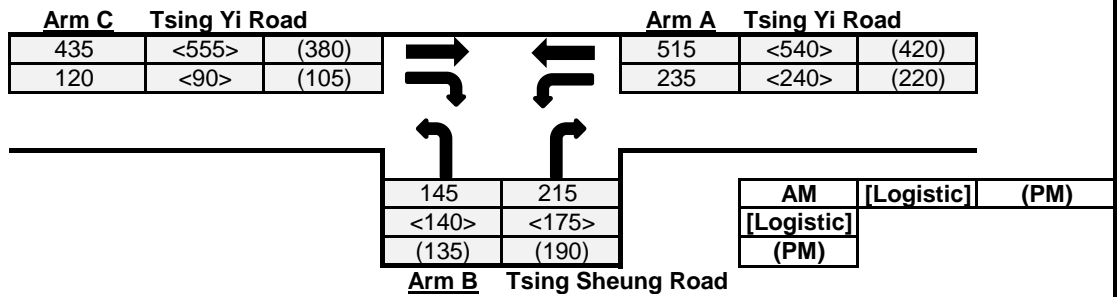

The predictive equations of capacity of movement are:

$$Q-BA = D(627 + 14W-CR - Y(0.364q-AC + 0.144q-AB + 0.229q-CA + 0.52q-CB))$$

$$Q-BC = E(745 - Y(0.364q-AC + 0.144q-AB))$$

$$Q-CB = F(745 - 0.364Y(q-AC + q-AB))$$

The geometric parameters represented by D, E, F are:

$$D = (1 + 0.094(w-BA - 3.65))(1 + 0.0009(V-rBA - 120))(1 + 0.0006(V-IBA - 150))$$

$$E = (1 + 0.094(w-BC - 3.65))(1 + 0.0009(V-rBC - 120))$$

$$F = (1 + 0.094(w-CB - 3.65))(1 + 0.0009(V-rCB - 120))$$

where

- Y = 1 - 0.0345W
- q-AB, etc = the design flow of movement AB, etc
- W = major road width
- W-CR = central reserve width
- w-BA, etc = lane width to vehicle
- v-rBA, etc = visibility to the right for waiting vehicles in stream BA, etc
- v-IBA = visibility to the left for waiting vehicles in stream BA, etc

Geometry :	Input	Calculated
W	14	D 0.951
W-CR	0	E 1.012
C-B blocked C-A, residual width <2.5m? (Yes: 1, No: 0)	0	F 0.616
Minor Road Share LT&RT? (Yes: 1, No: 0)	0	Y 0.517

Analysis :	Traffic Flow	AM	Logistic	PM	Capacity	AM	Logistic	PM	
	pcu/hr				pcu/hr				
	q-CA	435	555	380	Q-BA	408	397	436	
	q-CB	120	90	105	Q-BC	638	633	657	
	q-AB	235	240	220	Q-CB	372	368	384	
	q-AC	515	540	420	Q-CA	N/A	N/A	N/A	(If C-B blocked C-
	q-BA	215	175	190	Q-BAC	N/A	N/A	N/A	(If Minor Road Share
	q-BC	145	140	135					LT&RT)
	f	0.403	0.444	0.415					

Results :	Ratio of Flow-to-Capacity	AM	Logistic	PM
	B-A	0.53	0.44	0.44
	B-C	0.23	0.22	0.21
	C-B	0.32	0.24	0.27
	C-A	N/A	N/A	N/A
	B-AC	N/A	N/A	N/A

Critical DFC **0.53** **0.44** **0.44**

Priority Junction Calculation

Junction : (J6) Sai Tso Wan Road / Tsing Tim Street Job No.: 24001HK
 Scenario : 2029 Design Traffic Flow

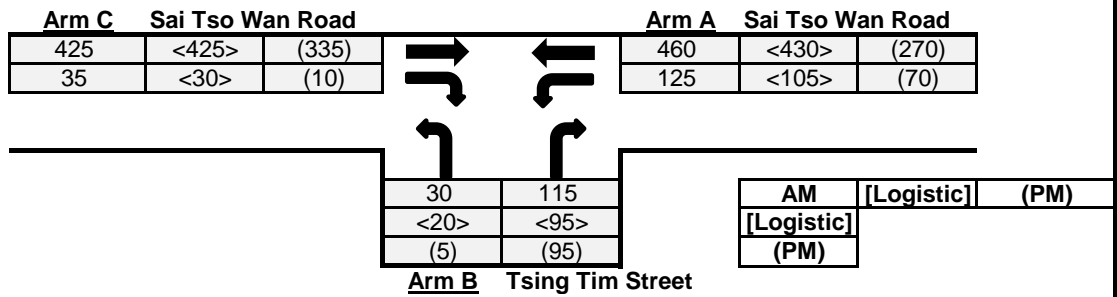

The predictive equations of capacity of movement are:

$$Q-BA = D(627 + 14W-CR - Y(0.364q-AC + 0.144q-AB + 0.229q-CA + 0.52q-CB))$$

$$Q-BC = E(745 - Y(0.364q-AC + 0.144q-AB))$$

$$Q-CB = F(745 - 0.364Y(q-AC + q-AB))$$

The geometric parameters represented by D, E, F are:

$$D = (1 + 0.094(w-BA - 3.65))(1 + 0.0009(V-rBA - 120))(1 + 0.0006(V-IBA - 150))$$

$$E = (1 + 0.094(w-BC - 3.65))(1 + 0.0009(V-rBC - 120))$$

$$F = (1 + 0.094(w-CB - 3.65))(1 + 0.0009(V-rCB - 120))$$

where

- Y = 1 - 0.0345W
- q-AB, etc = the design flow of movement AB, etc
- W = major road width
- W-CR = central reserve width
- w-BA, etc = lane width to vehicle
- v-rBA, etc = visibility to the right for waiting vehicles in stream BA, etc
- v-IBA = visibility to the left for waiting vehicles in stream BA, etc

Geometry :	Input	Calculated
W	7	D 0.827
W-CR	0	E 0.880
C-B blocked C-A, residual width <2.5m? (Yes: 1, No: 0)	0	F 0.616
Minor Road Share LT&RT? (Yes: 1, No: 0)	0	Y 0.759
V-rBA	50	
V-IBA	50	
V-rBC	50	
V-rCB	50	
w-BA	3	
w-BC	3	
w-CB	0	

Analysis :	Traffic Flow	AM	Logistic	PM	Capacity	AM	Logistic	PM	
	pcu/hr				pcu/hr				
q-CA	425	425	335	330	340	399			(If C-B blocked C- (If Minor Road Share LT&RT)
q-CB	35	30	10	Q-BC	532	541	583		
q-AB	125	105	70	Q-CB	359	368	401		
q-AC	460	430	270	Q-CA	N/A	N/A	N/A		
q-BA	115	95	95	Q-BAC	N/A	N/A	N/A		
q-BC	30	20	5						
f	0.207	0.174	0.050						

Results :	Ratio of Flow-to-Capacity	AM	Logistic	PM
B-A	0.35	0.28	0.24	
B-C	0.06	0.04	0.01	
C-B	0.10	0.08	0.02	
C-A	N/A	N/A	N/A	
B-AC	N/A	N/A	N/A	
Critical DFC	0.35	0.28	0.24	

Roundabout Junction Calculation

Junction : (RA1) Tsing Yi Interchange (North) Job No.: 24002HK

Scenario : 2024 Observed Traffic Flow

1140	<925>	(555)
------	-------	-------

0	400	0
<0>	<300>	<0>
(0)	(305)	(0)

400	<300>	(305)
-----	-------	-------

1485	<1240>	(780)
------	--------	-------

0	<0>	(305)
---	-----	-------

345	1140	0
<315>	<925>	<0>
(225)	(555)	(0)

AM	[Logistic]	(PM)
[Logistic]		
(PM)		

Input Parameters		Arm 1	Arm 2	Arm 3	Arm 4
V	= Approach half width (m)		6		6
E	= Entry width (m)		7		7
L	= Effective length of flare (m)		5		5
R	= Entry radius		62		41
D	= Inscribed circle diameter (m)		60		60
A	= Entry angle (degree)		27		39
Q	= Entry flow (pcu/hr)	AM	1485		400
		Logistic	1240		300
		PM	780		305
Qc	= Circulating flow across entry (pcu/hr)	AM	0		1140
		Logistic	0		925
		PM	305		555

Output Parameters		Arm 1	Arm 2	Arm 3	Arm 4
S	= Sharpness of flare = $1.6*(E-V)/L$		0.32		0.32
K	= $1-0.00347*(A-30)-0.978*(1/R-0.05)$		1.04		0.99
X2	= $V+((E-V)/(1+2*S))$		6.61		6.61
M	= $Exp((D-60)/10)$		1.00		1.00
F	= $303*X2$		2003		2003
Td	= $1+(0.5/(1+M))$		1.25		1.25
Fc	= $0.21*Td*(1+0.2*X2)$		0.61		0.61
Qe	= Capacity = $K*(F-Fc*Qc)$	AM	2090		1300
		Logistic	2090		1430
		PM	1896		1654
DFC	= Entry Flow/Capacity = Q/Qe	AM	0.71		0.31
		Logistic	0.59		0.21
		PM	0.41		0.18

DFC of Critical Approach	=	AM	0.71		
		Logistic	0.59		
		PM	0.41		

Roundabout Junction Calculation

Junction : (RA1) Tsing Yi Interchange (South) Job No.: 24002HK

Scenario : 2024 Observed Traffic Flow

615	<490>	(400)
365	<285>	(270)
30	<20>	(35)
0	<0>	(0)

0	560	0
<0>	<585>	<0>
(0)	(635)	(0)

590	<605>	(670)
-----	-------	-------

0	<0>	(0)
235	<250>	(355)
480	<410>	(255)

1295	<1045>	(1270)
840	220	0
<610>	<185>	<0>
(820)	(95)	(0)

235	<250>	(990)
-----	-------	-------

AM	[Logistic]	(PM)
[Logistic]		
(PM)		

Input Parameters		Arm 1	Arm 2	Arm 3	Arm 4	
V	= Approach half width (m)	7	6.8	7	6	
E	= Entry width (m)	7.2	7	7.3	6.3	
L	= Effective length of flare (m)	5	5	5	5	
R	= Entry radius	23	25	24	44	
D	= Inscribed circle diameter (m)	60	60	60	60	
A	= Entry angle (degree)	43	54	27	23	
Q	= Entry flow (pcu/hr)	715	1060	395	560	
		Logistic	660	795	305	585
		PM	610	915	305	635
Qc	= Circulating flow across entry (pcu/hr)	590	235	1295	615	
		Logistic	605	250	1045	490
		PM	670	990	1270	400

Output Parameters		Arm 1	Arm 2	Arm 3	Arm 4	
S	= Sharpness of flare = $1.6*(E-V)/L$	0.06	0.06	0.10	0.10	
K	= $1-0.00347*(A-30)-0.978*(1/R-0.05)$	0.96	0.93	1.02	1.05	
X2	= $V+((E-V)/(1+2*S))$	7.18	6.98	7.25	6.25	
M	= $Exp((D-60)/10)$	1.00	1.00	1.00	1.00	
F	= $303*X2$	2175	2114	2197	1894	
Td	= $1+(0.5/(1+M))$	1.25	1.25	1.25	1.25	
Fc	= $0.21*Td*(1+0.2*X2)$	0.64	0.63	0.64	0.59	
Qe	= Capacity = $K*(F-Fc*Qc)$	1728	1822	1390	1609	
		Logistic	1719	1813	1553	1687
		PM	1679	1382	1406	1742
DFC	= Entry Flow/Capacity = Q/Qe	0.41	0.58	0.28	0.35	
		Logistic	0.38	0.44	0.20	0.35
		PM	0.36	0.66	0.22	0.36

DFC of Critical Approach	=	AM	0.58
		Logistic	0.44
		PM	0.66

Roundabout Junction Calculation

Junction : (RA2) Tsing Yi Road / Tsing Hung Road Job No.: 24002HK

Scenario : 2024 Observed Traffic Flow

0	150	625	865
<0>	<120>	<525>	<745>
(5)	(85)	(395)	(660)

130	<130>	(170)
415	<380>	(445)
300	<295>	(315)
60	<60>	(45)

65	<55>	(80)
365	<355>	(280)
215	<205>	(200)
5	<5>	(5)

265	655	80	40
<260>	<685>	<80>	<50>
(220)	(690)	(60)	(45)

Input Parameters		Arm 1	Arm 2	Arm 3	Arm 4
V	= Approach half width (m)	9.5	9	7.3	7.5
E	= Entry width (m)	13.5	12	11.5	11.5
L	= Effective length of flare (m)	30	15	30	15
R	= Entry radius	45	97	52	34
D	= Inscribed circle diameter (m)	110	110	110	110
A	= Entry angle (degree)	61	32	31	46
Q	= Entry flow (pcu/hr)	AM 905 Logistic 865 PM 975	1040 1075 1015	650 620 565	1640 1390 1145
Qc	= Circulating flow across entry (pcu/hr)	AM 1035 Logistic 905 PM 735	1000 930 1420	1320 1325 1415	835 825 760

Output Parameters		Arm 1	Arm 2	Arm 3	Arm 4
S	= Sharpness of flare = 1.6*(E-V)/L	0.21	0.32	0.22	0.43
K	= 1-0.00347*(A-30)-0.978*(1/R-0.05)	0.92	1.03	1.03	0.96
X2	= V+((E-V)/(1+2*S))	12.30	10.83	10.20	9.66
M	= Exp((D-60)/10)	148.41	148.41	148.41	148.41
F	= 303*X2	3728	3281	3091	2926
Td	= 1+(0.5/(1+M))	1.00	1.00	1.00	1.00
Fc	= 0.21*Td*(1+0.2*X2)	0.73	0.67	0.64	0.62
Qe	= Capacity = K*(F-Fc*Qc)	AM 2734 Logistic 2821 PM 2935	2698 2746 2408	2305 2302 2243	2325 2331 2370
DFC	= Entry Flow/Capacity = Q/Qe	AM 0.33 Logistic 0.31 PM 0.33	0.39 0.39 0.42	0.28 0.27 0.25	0.71 0.60 0.48

DFC of Critical Approach	=	AM	0.71	
		Logistic	0.60	
		PM	0.48	

Roundabout Junction Calculation

Junction : (RA3) Tsing Yi Hong Wan Road Job No.: 24002HK
 Scenario : 2024 Observed Traffic Flow

Arm 4 Tsing Yi Hong Wan Road SB

180		855
<155>		<700>
(175)		(720)

Arm 1

1060	<880>	(935)
------	-------	-------

Arm 3

25	<25>	(40)
----	------	------

Arm 2 Tsing Yi Hong Wan Road NB

895	<900>	(1105)
	690	25
	<720>	<25>
	(890)	(40)

AM	[Logistic]	(PM)
[Logistic]		
(PM)		

Input Parameters

		Arm 1	Arm 2	Arm 3	Arm 4
V	=	Approach half width (m)	7		10
E	=	Entry width (m)	14		12
L	=	Effective length of flare (m)	20		2
R	=	Entry radius	65		75
D	=	Inscribed circle diameter (m)	68		68
A	=	Entry angle (degree)	53		46
Q	=	Entry flow (pcu/hr)	AM 715 Logistic 745 PM 930		1035 855 895
Qc	=	Circulating flow across entry (pcu/hr)	AM 180 Logistic 155 PM 895		25 25 40

Output Parameters

		Arm 1	Arm 2	Arm 3	Arm 4
S	=	Sharpness of flare = $1.6*(E-V)/L$	0.56		1.60
K	=	$1-0.00347*(A-30)-0.978*(1/R-0.05)$	0.95		0.98
X2	=	$V+((E-V)/(1+2*S))$	10.30		10.48
M	=	$Exp((D-60)/10)$	2.23		2.23
F	=	$303*X2$	3121		3174
Td	=	$1+(0.5/(1+M))$	1.16		1.16
Fc	=	$0.21*Td*(1+0.2*X2)$	0.74		0.75
Qe	=	Capacity = $K*(F-Fc*Qc)$	AM 2851 Logistic 2868 PM 2344		3093 3093 3082
DFC	=	Entry Flow/Capacity = Q/Qe	AM 0.25 Logistic 0.26 PM 0.40		0.33 0.28 0.29

DFC of Critical Approach = AM 0.33
Logistic 0.28
PM 0.40

Roundabout Junction Calculation

Junction : (RA4) Tsing Yi Hong Wan Road / Tsing Ko Road Job No.: 24002HK

Scenario : 2024 Observed Traffic Flow

Arm 4 Tsing Yi Hong Wan Road SB			
450		245	180
<365>		<230>	<155>
(345)		(200)	(250)

Arm 1 Tsing Yi Hong Wan Road			
710	<1105>	(1065)	

Arm 3 Tsing Ko Road			
560	<645>	(655)	

Arm 2 Tsing Yi Hong Wan Road NB			
25	110		0
<25>	<140>		<140>
(20)	(155)		(155)

	AM	[Logistic]	(PM)
	[Logistic]		
	(PM)		

Input Parameters		Arm 1	Arm 2	Arm 3	Arm 4
V	= Approach half width (m)		6.7	6.3	7.6
E	= Entry width (m)		13.5	12.5	15.5
L	= Effective length of flare (m)		18	30	30
R	= Entry radius		47	180	75
D	= Inscribed circle diameter (m)		68	68	68
A	= Entry angle (degree)		41	22	46
Q	= Entry flow (pcu/hr)	AM	135	330	875
		Logistic	305	525	750
		PM	330	615	795
Qc	= Circulating flow across entry (pcu/hr)	AM	455	560	15
		Logistic	730	645	510
		PM	890	655	520

Output Parameters		Arm 1	Arm 2	Arm 3	Arm 4
S	= Sharpness of flare = $1.6*(E-V)/L$		0.60	0.33	0.42
K	= $1-0.00347*(A-30)-0.978*(1/R-0.05)$		0.99	1.07	0.98
X2	= $V+((E-V)/(1+2*S))$		9.78	10.03	11.89
M	= $Exp((D-60)/10)$		2.23	2.23	2.23
F	= $303*X2$		2963	3040	3602
Td	= $1+(0.5/(1+M))$		1.16	1.16	1.16
Fc	= $0.21*Td*(1+0.2*X2)$		0.72	0.73	0.82
Qe	= Capacity = $K*(F-Fc*Qc)$	AM	2610	2819	3519
		Logistic	2415	2752	3121
		PM	2301	2745	3113
DFC	= Entry Flow/Capacity = Q/Qe	AM	0.05	0.12	0.25
		Logistic	0.13	0.19	0.24
		PM	0.14	0.22	0.26

DFC of Critical Approach	=	AM	0.25
		Logistic	0.24
		PM	0.26

Roundabout Junction Calculation

Junction : (RA5) Tam Kon Shan Interchange Job No.: 24002HK

Scenario : 2024 Observed Traffic Flow

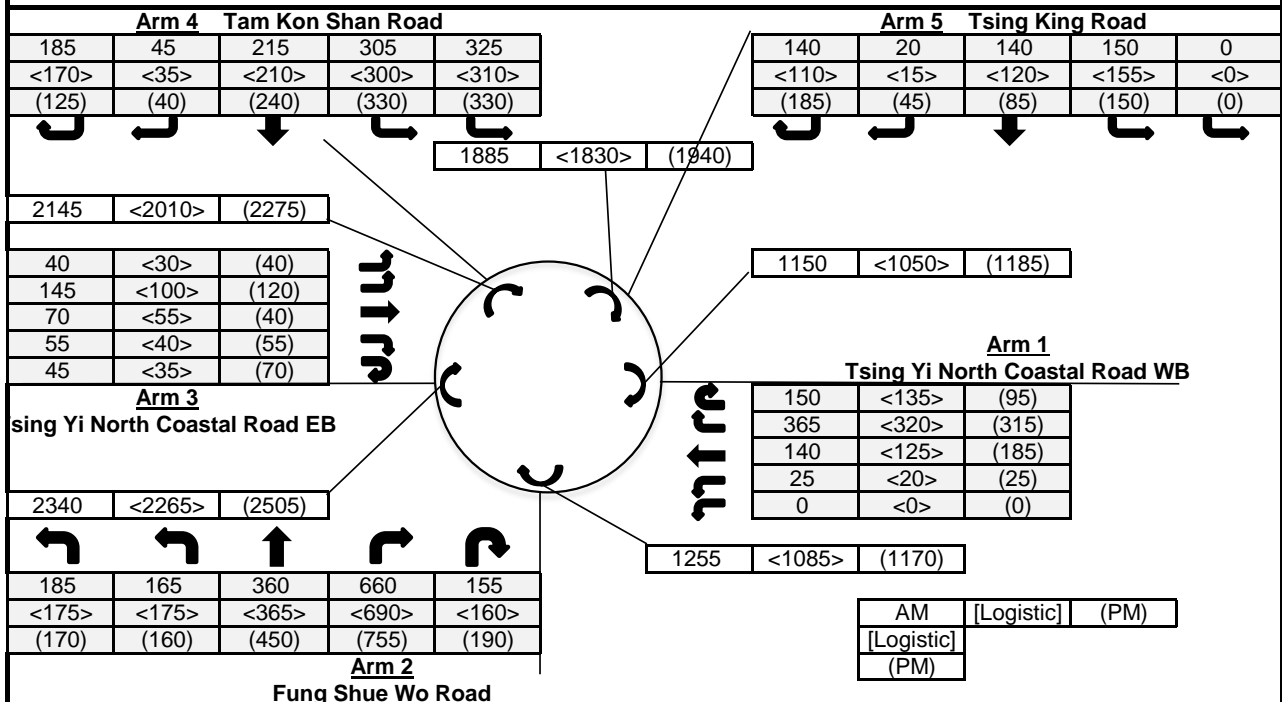

Input Parameters			Arm 1	Arm 2	Arm 3	Arm 4	Arm 5
V	=	Approach half width (m)	7	10	5.5	8	7.5
E	=	Entry width (m)	9	13.5	7.5	13.5	11
L	=	Effective length of flare (m)	9	9	11	9	10
R	=	Entry radius	100	45	45	25	45
D	=	Inscribed circle diameter (m)	115	115	115	115	115
A	=	Entry angle (degree)	30	25	25	30	45
Q	=	Entry flow (pcu/hr)					
		AM	680	1525	355	1075	450
		Logistic	600	1565	260	1025	400
		PM	620	1725	325	1065	465
Qc	=	Circulating flow across entry (pcu/hr)					
		AM	1150	1255	2340	2145	1885
		Logistic	1050	1085	2265	2010	1830
		PM	1185	1170	2505	2275	1940

Output Parameters			Arm 1	Arm 2	Arm 3	Arm 4	Arm 5
S	=	Sharpness of flare = $1.6*(E-V)/L$	0.36	0.62	0.29	0.98	0.56
K	=	$1-0.00347*(A-30)-0.978*(1/R-0.05)$	1.04	1.04	1.04	1.01	0.98
X2	=	$V+((E-V)/(1+2*S))$	8.17	11.56	6.76	9.86	9.15
M	=	$Exp((D-60)/10)$	244.69	244.69	244.69	244.69	244.69
F	=	$303*X2$	2475	3503	2050	2988	2773
Td	=	$1+(0.5/(1+M))$	1.00	1.00	1.00	1.00	1.00
Fc	=	$0.21*Td*(1+0.2*X2)$	0.55	0.70	0.50	0.63	0.60
Qe	=	Capacity = $K*(F-Fc*Qc)$					
		AM	1910	2745	931	1662	1609
		Logistic	1967	2869	970	1748	1641
		PM	1890	2807	845	1580	1577
DFC	=	Entry Flow/Capacity = Q/Qe					
		AM	0.36	0.56	0.38	0.65	0.28
		Logistic	0.30	0.55	0.27	0.59	0.24
		PM	0.33	0.61	0.38	0.67	0.29

DFC of Critical Approach	=	AM	0.65
		Logistic	0.59
		PM	0.67

Roundabout Junction Calculation

Junction : (RA6) Tsing King Road / Fung Shue Wo Road Job No.: 24002HK

Scenario : 2024 Observed Traffic Flow

AM	[Logistic]	(PM)
[Logistic]		
(PM)		

Input Parameters		Arm 1	Arm 2	Arm 3	Arm 4	
V	= Approach half width (m)	6.7	7.3	7.3	6.9	
E	= Entry width (m)	9.7	10	9.2	8.9	
L	= Effective length of flare (m)	16	20	14	16	
R	= Entry radius	55	71	60	62	
D	= Inscribed circle diameter (m)	112	112	112	112	
A	= Entry angle (degree)	36	30	18	25	
Q	= Entry flow (pcu/hr)	AM	310	1075	430	695
		Logistic	240	900	330	485
		PM	285	970	450	530
Qc	= Circulating flow across entry (pcu/hr)	AM	1370	130	850	925
		Logistic	1035	110	730	755
		PM	1100	555	685	785

Output Parameters		Arm 1	Arm 2	Arm 3	Arm 4	
S	= Sharpness of flare = $1.6*(E-V)/L$	0.30	0.22	0.22	0.20	
K	= $1-0.00347*(A-30)-0.978*(1/R-0.05)$	1.01	1.04	1.07	1.05	
X2	= $V+((E-V)/(1+2*S))$	8.58	9.19	8.62	8.33	
M	= $Exp((D-60)/10)$	181.27	181.27	181.27	181.27	
F	= $303*X2$	2598	2783	2613	2524	
Td	= $1+(0.5/(1+M))$	1.00	1.00	1.00	1.00	
Fc	= $0.21*Td*(1+0.2*X2)$	0.57	0.60	0.57	0.56	
Qe	= Capacity = $K*(F-Fc*Qc)$	AM	1834	2801	2283	2105
		Logistic	2027	2813	2357	2206
		PM	1990	2538	2385	2188
DFC	= Entry Flow/Capacity = Q/Qe	AM	0.17	0.38	0.19	0.33
		Logistic	0.12	0.32	0.14	0.22
		PM	0.14	0.38	0.19	0.24

DFC of Critical Approach	=				
		AM	0.38		
		Logistic	0.32		
		PM	0.38		

Roundabout Junction Calculation

Junction : (RA7) Tsing Yi Hong Wan Road / Tsing Sheung Road Job No.: 24002HK

Scenario : 2024 Observed Traffic Flow

Arm 4

70		90	40
<115>		<90>	<30>
(110)		(145)	(25)

Arm 1
Tsing Sheung Road

165	<210>	(270)
-----	-------	-------

Arm 3
Tsing Yi Hong Wan Road

130	<145>	(165)
-----	-------	-------

Arm 2
Tsing Sheung Road

5	50	5
<5>	<25>	<0>
(10)	(40)	(5)

Input Parameters

	Arm 1	Arm 2	Arm 3	Arm 4
V = Approach half width (m)		5.2	3	6.7
E = Entry width (m)		9	8.4	12
L = Effective length of flare (m)		25	15	23
R = Entry radius		63	55	145
D = Inscribed circle diameter (m)		53	53	53
A = Entry angle (degree)		33	48	38
Q = Entry flow (pcu/hr)	AM	60	35	200
	Logistic	30	30	235
	PM	55	75	280
Qc = Circulating flow across entry (pcu/hr)	AM	70	130	65
	Logistic	120	145	35
	PM	265	165	65

Output Parameters

	Arm 1	Arm 2	Arm 3	Arm 4
S = Sharpness of flare = 1.6*(E-V)/L		0.24	0.58	0.37
K = 1-0.00347*(A-30)-0.978*(1/R-0.05)		1.02	0.97	1.01
X2 = V+((E-V)/(1+2*S))		7.76	5.51	9.75
M = Exp((D-60)/10)		0.50	0.50	0.50
F = 303*X2		2350	1669	2954
Td = 1+(0.5/(1+M))		1.33	1.33	1.33
Fc = 0.21*Td*(1+0.2*X2)		0.71	0.59	0.83
Qe = Capacity = K*(F-Fc*Qc)	AM	2353	1543	2942
	Logistic	2316	1534	2968
	PM	2210	1523	2942
DFC = Entry Flow/Capacity = Q/Qe	AM	0.03	0.02	0.07
	Logistic	0.01	0.02	0.08
	PM	0.02	0.05	0.10

DFC of Critical Approach =

AM	0.07
Logistic	0.08
PM	0.10

CTA Consultants Ltd.

Roundabout Junction Calculation

Junction : (RA8) Tsing Yi Road / Ching Hong Road Job No.: 24002HK

Scenario : 2024 Observed Traffic Flow

AM	[Logistic]	(PM)
[Logistic]		
(PM)		

Input Parameters		Arm 1	Arm 2	Arm 3	Arm 4
V	= Approach half width (m)		6.5	7.5	8
E	= Entry width (m)		8.6	8.5	9
L	= Effective length of flare (m)		12	4	16
R	= Entry radius		24.5	30	28
D	= Inscribed circle diameter (m)		30	30	30
A	= Entry angle (degree)		44	40	62
Q	= Entry flow (pcu/hr)		275	735	945
		AM			
		Logistic	370	565	790
		PM	430	545	750
Qc	= Circulating flow across entry (pcu/hr)		655	435	340
		AM			
		Logistic	600	400	390
		PM	795	480	440

Output Parameters		Arm 1	Arm 2	Arm 3	Arm 4
S	= Sharpness of flare = $1.6*(E-V)/L$		0.28	0.40	0.10
K	= $1-0.00347*(A-30)-0.978*(1/R-0.05)$		0.96	0.98	0.90
X2	= $V+((E-V)/(1+2*S))$		7.85	8.06	8.83
M	= $Exp((D-60)/10)$		0.05	0.05	0.05
F	= $303*X2$		2377	2441	2677
Td	= $1+(0.5/(1+M))$		1.48	1.48	1.48
Fc	= $0.21*Td*(1+0.2*X2)$		0.80	0.81	0.86
Qe	= Capacity = $K*(F-Fc*Qc)$		1782	2050	2153
		AM			
		Logistic	1824	2078	2115
		PM	1675	2015	2076
DFC	= Entry Flow/Capacity = Q/Qe		0.15	0.36	0.44
		AM			
		Logistic	0.20	0.27	0.37
		PM	0.26	0.27	0.36

DFC of Critical Approach	=	AM	0.44
		Logistic	0.37
		PM	0.36

Roundabout Junction Calculation

Junction : (RA9) Tam Kon Shan Road Job No.: 24002HK
 Scenario : 2024 Observed Traffic Flow

Arm 4 Development Access

0	0	0
<0>	<0>	<5>
(0)	(0)	(5)

Arm 1 Tsing Hung Road

15	<5>	(15)
0	<5>	(0)
25	<35>	(10)

Arm 3 Tam Kon Shan Road

0	<0>	(0)
45	<55>	(40)
5	<0>	(5)

Arm 2 Tsing Yi North Coastal Road

25	10	55	
<30>	<0>	<85>	
(40)	(10)	(65)	

Summary Table

120	<145>	(125)	
5	<0>	(5)	
80	<95>	(90)	
45	<45>	(30)	

Input Parameters

		Arm 1	Arm 2	Arm 3	Arm 4	
V	=	Approach half width (m)	3.3	4	3.4	8.5
E	=	Entry width (m)	3.9	4.9	5.8	15.1
L	=	Effective length of flare (m)	10	10	10	10
R	=	Entry radius	32	97	52	34
D	=	Inscribed circle diameter (m)	108	108	108	108
A	=	Entry angle (degree)	61	32	31	46
Q	=	Entry flow (pcu/hr)	AM 40 Logistic 45 PM 25	90 115 115	50 55 45	0 5 5
Qc	=	Circulating flow across entry (pcu/hr)	AM 5 Logistic 0 PM 5	45 45 30	80 95 90	120 145 125

Output Parameters

		Arm 1	Arm 2	Arm 3	Arm 4	
S	=	Sharpness of flare = $1.6*(E-V)/L$	0.10	0.14	0.38	1.06
K	=	$1-0.00347*(A-30)-0.978*(1/R-0.05)$	0.91	1.03	1.03	0.96
X2	=	$V+((E-V)/(1+2*S))$	3.80	4.70	4.76	10.62
M	=	$Exp((D-60)/10)$	121.51	121.51	121.51	121.51
F	=	$303*X2$	1152	1424	1442	3218
Td	=	$1+(0.5/(1+M))$	1.00	1.00	1.00	1.00
Fc	=	$0.21*Td*(1+0.2*X2)$	0.37	0.41	0.41	0.66
Qe	=	Capacity = $K*(F-Fc*Qc)$	AM 1048 Logistic 1050 PM 1048	1450 1450 1456	1446 1440 1442	3028 3012 3025
DFC	=	Entry Flow/Capacity = Q/Qe	AM 0.04 Logistic 0.04 PM 0.02	0.06 0.08 0.08	0.03 0.04 0.03	0.00 0.00 0.00

DFC of Critical Approach

AM	0.06
Logistic	0.08
PM	0.08

Roundabout Junction Calculation

Junction : (RA10) Tsing Sheung Road / Tsing Ko Road Job No.: 24002HK

Scenario : 2024 Observed Traffic Flow

AM	[Logistic]	(PM)
[Logistic]		
(PM)		

Input Parameters		Arm 1	Arm 2	Arm 3	Arm 4
V	= Approach half width (m)	6.6		5.6	6.4
E	= Entry width (m)	12.9		16	11.6
L	= Effective length of flare (m)	18		30	30
R	= Entry radius	47		180	75
D	= Inscribed circle diameter (m)	68		68	68
A	= Entry angle (degree)	41		22	46
Q	= Entry flow (pcu/hr)	AM 170		425	210
		Logistic 170		400	225
		PM 255		300	160
Qc	= Circulating flow across entry (pcu/hr)	AM 230		65	115
		Logistic 245		100	100
		PM 175		105	85

Output Parameters		Arm 1	Arm 2	Arm 3	Arm 4
S	= Sharpness of flare = $1.6*(E-V)/L$	0.56		0.55	0.28
K	= $1-0.00347*(A-30)-0.978*(1/R-0.05)$	0.99		1.07	0.98
X2	= $V+((E-V)/(1+2*S))$	9.57		10.53	9.74
M	= $Exp((D-60)/10)$	2.23		2.23	2.23
F	= $303*X2$	2900		3191	2953
Td	= $1+(0.5/(1+M))$	1.16		1.16	1.16
Fc	= $0.21*Td*(1+0.2*X2)$	0.71		0.75	0.72
Qe	= Capacity = $K*(F-Fc*Qc)$	AM 2710		3366	2814
		Logistic 2700		3337	2824
		PM 2749		3333	2835
DFC	= Entry Flow/Capacity = Q/Qe	AM 0.06		0.13	0.07
		Logistic 0.06		0.12	0.08
		PM 0.09		0.09	0.06

DFC of Critical Approach	=	AM	0.13
		Logistic	0.12
		PM	0.09

Roundabout Junction Calculation

Junction : (RA1) Tsing Yi Interchange (North) Job No.: 24002HK

Scenario : 2029 Design Traffic Flow

1240	<1005>	(610)
------	--------	-------

0	420	0
<0>	<315>	<0>
(0)	(320)	(0)

420	<315>	(320)
-----	-------	-------

1605	<1335>	(845)
365	1240	0
<330>	<1005>	<0>
(235)	(610)	(0)

0	<0>	(320)
---	-----	-------

AM	[Logistic]	(PM)
[Logistic]		
(PM)		

Input Parameters		Arm 1	Arm 2	Arm 3	Arm 4
V	= Approach half width (m)		6		6
E	= Entry width (m)		7		7
L	= Effective length of flare (m)		5		5
R	= Entry radius		62		41
D	= Inscribed circle diameter (m)		60		60
A	= Entry angle (degree)		27		39
Q	= Entry flow (pcu/hr)		1605		420
		AM			
		Logistic	1335		315
		PM	845		320
Qc	= Circulating flow across entry (pcu/hr)		0		1240
		AM			
		Logistic	0		1005
		PM	320		610

Output Parameters		Arm 1	Arm 2	Arm 3	Arm 4
S	= Sharpness of flare = $1.6*(E-V)/L$		0.32		0.32
K	= $1-0.00347*(A-30)-0.978*(1/R-0.05)$		1.04		0.99
X2	= $V+((E-V)/(1+2*S))$		6.61		6.61
M	= $Exp((D-60)/10)$		1.00		1.00
F	= $303*X2$		2003		2003
Td	= $1+(0.5/(1+M))$		1.25		1.25
Fc	= $0.21*Td*(1+0.2*X2)$		0.61		0.61
Qe	= Capacity = $K*(F-Fc*Qc)$		2090		1239
		AM			
		Logistic	2090		1382
		PM	1886		1621
DFC	= Entry Flow/Capacity = Q/Qe		0.77		0.34
		AM			
		Logistic	0.64		0.23
		PM	0.45		0.20

DFC of Critical Approach	=	AM	0.77
		Logistic	0.64
		PM	0.45

Roundabout Junction Calculation

Junction : (RA1) Tsing Yi Interchange (South) Job No.: 24002HK

Scenario : 2029 Design Traffic Flow

Arm 4 Kwai Tsing Road

	0	625	0
	<0>	<650>	<0>
	(0)	(700)	(0)

Arm 1 Tsing Yi Road WB

	0	<0>	(0)
	245	<265>	(375)
	505	<430>	(270)

Arm 2 Tsing Yi Road NB

	925	230	0
	<675>	<195>	<0>
	(885)	(100)	(0)

Arm 3 Tsing Yi Road SB

	645	<515>	(420)
	385	<300>	(285)
	30	<20>	(35)
	0	<0>	(0)

Central Roundabout

	655	<670>	(735)
	245	<265>	(1075)

Time Periods

AM	[Logistic]	(PM)
[Logistic]		
(PM)		

Input Parameters

		Arm 1	Arm 2	Arm 3	Arm 4	
V	=	Approach half width (m)	7	6.8	7	6
E	=	Entry width (m)	7.2	7	7.3	6.3
L	=	Effective length of flare (m)	5	5	5	5
R	=	Entry radius	23	25	24	44
D	=	Inscribed circle diameter (m)	60	60	60	60
A	=	Entry angle (degree)	43	54	27	23
Q	=	Entry flow (pcu/hr)				
		AM	750	1155	415	625
		Logistic	695	870	320	650
		PM	645	985	320	700
Qc	=	Circulating flow across entry (pcu/hr)				
		AM	655	245	1400	645
		Logistic	670	265	1135	515
		PM	735	1075	1360	420

Output Parameters

		Arm 1	Arm 2	Arm 3	Arm 4	
S	=	Sharpness of flare = $1.6*(E-V)/L$	0.06	0.06	0.10	0.10
K	=	$1-0.00347*(A-30)-0.978*(1/R-0.05)$	0.96	0.93	1.02	1.05
X2	=	$V+((E-V)/(1+2*S))$	7.18	6.98	7.25	6.25
M	=	$Exp((D-60)/10)$	1.00	1.00	1.00	1.00
F	=	$303*X2$	2175	2114	2197	1894
Td	=	$1+(0.5/(1+M))$	1.25	1.25	1.25	1.25
Fc	=	$0.21*Td*(1+0.2*X2)$	0.64	0.63	0.64	0.59
Qe	=	Capacity = $K*(F-Fc*Qc)$				
		AM	1688	1816	1321	1590
		Logistic	1679	1804	1494	1671
		PM	1639	1332	1347	1730
DFC	=	Entry Flow/Capacity = Q/Qe				
		AM	0.44	0.64	0.31	0.39
		Logistic	0.41	0.48	0.21	0.39
		PM	0.39	0.74	0.24	0.40

DFC of Critical Approach

		AM	0.64
		Logistic	0.48
		PM	0.74

CTA Consultants Ltd.

Roundabout Junction Calculation

Junction : <u>(RA2) Tsing Yi Road / Tsing Hung Road</u>		Job No.: <u>24002HK</u>																					
Scenario : <u>2029 Design Traffic Flow</u>																							
<table border="1" style="width:100%; border-collapse: collapse;"> <tr> <td colspan="4" style="text-align: center;">Arm 4 Tsing Yi Road SB</td> </tr> <tr> <td>0</td><td>160</td><td>655</td><td>910</td> </tr> <tr> <td><0></td><td><125></td><td><550></td><td><785></td> </tr> <tr> <td>(5)</td><td>(90)</td><td>(415)</td><td>(695)</td> </tr> </table>				Arm 4 Tsing Yi Road SB				0	160	655	910	<0>	<125>	<550>	<785>	(5)	(90)	(415)	(695)				
Arm 4 Tsing Yi Road SB																							
0	160	655	910																				
<0>	<125>	<550>	<785>																				
(5)	(90)	(415)	(695)																				
<table border="1" style="width:100%; border-collapse: collapse;"> <tr> <td colspan="4" style="text-align: center;">Arm 1 Tsing Yi Hong Road</td> </tr> <tr> <td>135</td><td><135></td><td>(180)</td><td></td> </tr> <tr> <td>435</td><td><400></td><td>(470)</td><td></td> </tr> <tr> <td>315</td><td><310></td><td>(330)</td><td></td> </tr> <tr> <td>65</td><td><65></td><td>(45)</td><td></td> </tr> </table>				Arm 1 Tsing Yi Hong Road				135	<135>	(180)		435	<400>	(470)		315	<310>	(330)		65	<65>	(45)	
Arm 1 Tsing Yi Hong Road																							
135	<135>	(180)																					
435	<400>	(470)																					
315	<310>	(330)																					
65	<65>	(45)																					
<table border="1" style="width:100%; border-collapse: collapse;"> <tr> <td colspan="4" style="text-align: center;">Arm 2 Tsing Yi Road NB</td> </tr> <tr> <td>295</td><td>690</td><td>85</td><td>40</td> </tr> <tr> <td><290></td><td><720></td><td><85></td><td><55></td> </tr> <tr> <td>(245)</td><td>(725)</td><td>(65)</td><td>(45)</td> </tr> </table>				Arm 2 Tsing Yi Road NB				295	690	85	40	<290>	<720>	<85>	<55>	(245)	(725)	(65)	(45)				
Arm 2 Tsing Yi Road NB																							
295	690	85	40																				
<290>	<720>	<85>	<55>																				
(245)	(725)	(65)	(45)																				
<table border="1" style="width:100%; border-collapse: collapse;"> <tr> <td colspan="4" style="text-align: center;">Arm 3 Tsing Sha Highway</td> </tr> <tr> <td>1385</td><td><1395></td><td>(1490)</td><td></td> </tr> </table>				Arm 3 Tsing Sha Highway				1385	<1395>	(1490)													
Arm 3 Tsing Sha Highway																							
1385	<1395>	(1490)																					
<table border="1" style="width:50%; border-collapse: collapse;"> <tr> <td>AM</td><td>[Logistic]</td><td>(PM)</td></tr> <tr> <td>[Logistic]</td><td></td><td></td></tr> <tr> <td>(PM)</td><td></td><td></td></tr> </table>				AM	[Logistic]	(PM)	[Logistic]			(PM)													
AM	[Logistic]	(PM)																					
[Logistic]																							
(PM)																							
Input Parameters																							
V	=	Approach half width (m)	Arm 1	Arm 2	Arm 3	Arm 4																	
E	=	Entry width (m)	9.5	9	7.3	7.5																	
L	=	Effective length of flare (m)	13.5	12	11.5	11.5																	
R	=	Entry radius	30	15	30	15																	
D	=	Inscribed circle diameter (m)	45	97	52	34																	
A	=	Entry angle (degree)	110	110	110	110																	
Q	=	Entry flow (pcu/hr)	61	32	31	46																	
Qc	=	Circulating flow across entry (pcu/hr)	AM	950	1110	700	1725																
			Logistic	910	1150	670	1460																
			PM	1025	1080	610	1205																
Qc	=	Circulating flow across entry (pcu/hr)	AM	1100	1050	1385	890																
			Logistic	965	975	1395	885																
			PM	785	1495	1490	815																
Output Parameters																							
S	=	Sharpness of flare = 1.6*(E-V)/L	Arm 1	Arm 2	Arm 3	Arm 4																	
K	=	1-0.00347*(A-30)-0.978*(1/R-0.05)	0.21	0.32	0.22	0.43																	
X2	=	V+((E-V)/(1+2*S))	0.92	1.03	1.03	0.96																	
M	=	Exp((D-60)/10)	12.30	10.83	10.20	9.66																	
F	=	303*X2	148.41	148.41	148.41	148.41																	
Td	=	1+(0.5/(1+M))	3728	3281	3091	2926																	
Fc	=	0.21*Td*(1+0.2*X2)	1.00	1.00	1.00	1.00																	
Qe	=	Capacity = K*(F-Fc*Qc)	0.73	0.67	0.64	0.62																	
DFC	=	Entry Flow/Capacity = Q/Qe	AM	2691	2663	2262	2293																
			Logistic	2781	2715	2256	2296																
			PM	2902	2357	2193	2337																
DFC	=	Entry Flow/Capacity = Q/Qe	AM	0.35	0.42	0.31	0.75																
			Logistic	0.33	0.42	0.30	0.64																
			PM	0.35	0.46	0.28	0.52																
DFC of Critical Approach																							
=				AM	0.75																		
				Logistic	0.64																		
				PM	0.52																		

Roundabout Junction Calculation

Junction : <u>(RA3) Tsing Yi Hong Wan Road</u>		Job No.: <u>24002HK</u>																																																																																	
Scenario : <u>2029 Design Traffic Flow</u>																																																																																			
<table border="1" style="width:100%; border-collapse: collapse;"> <thead> <tr> <th style="text-align: left;">Input Parameters</th> <th>Arm 1</th> <th>Arm 2</th> <th>Arm 3</th> <th>Arm 4</th> </tr> </thead> <tbody> <tr> <td>V = Approach half width (m)</td> <td></td> <td>7</td> <td></td> <td>10</td> </tr> <tr> <td>E = Entry width (m)</td> <td></td> <td>14</td> <td></td> <td>12</td> </tr> <tr> <td>L = Effective length of flare (m)</td> <td></td> <td>20</td> <td></td> <td>2</td> </tr> <tr> <td>R = Entry radius</td> <td></td> <td>65</td> <td></td> <td>75</td> </tr> <tr> <td>D = Inscribed circle diameter (m)</td> <td></td> <td>68</td> <td></td> <td>68</td> </tr> <tr> <td>A = Entry angle (degree)</td> <td></td> <td>53</td> <td></td> <td>46</td> </tr> <tr> <td>Q = Entry flow (pcu/hr)</td> <td></td> <td>750</td> <td></td> <td>1090</td> </tr> <tr> <td></td> <td>AM</td> <td>750</td> <td></td> <td>1090</td> </tr> <tr> <td></td> <td>Logistic</td> <td>780</td> <td></td> <td>900</td> </tr> <tr> <td></td> <td>PM</td> <td>975</td> <td></td> <td>940</td> </tr> <tr> <td>Qc = Circulating flow across entry (pcu/hr)</td> <td></td> <td>190</td> <td></td> <td>25</td> </tr> <tr> <td></td> <td>AM</td> <td>190</td> <td></td> <td>25</td> </tr> <tr> <td></td> <td>Logistic</td> <td>165</td> <td></td> <td>25</td> </tr> <tr> <td></td> <td>PM</td> <td>940</td> <td></td> <td>40</td> </tr> </tbody> </table>				Input Parameters	Arm 1	Arm 2	Arm 3	Arm 4	V = Approach half width (m)		7		10	E = Entry width (m)		14		12	L = Effective length of flare (m)		20		2	R = Entry radius		65		75	D = Inscribed circle diameter (m)		68		68	A = Entry angle (degree)		53		46	Q = Entry flow (pcu/hr)		750		1090		AM	750		1090		Logistic	780		900		PM	975		940	Qc = Circulating flow across entry (pcu/hr)		190		25		AM	190		25		Logistic	165		25		PM	940		40					
Input Parameters	Arm 1	Arm 2	Arm 3	Arm 4																																																																															
V = Approach half width (m)		7		10																																																																															
E = Entry width (m)		14		12																																																																															
L = Effective length of flare (m)		20		2																																																																															
R = Entry radius		65		75																																																																															
D = Inscribed circle diameter (m)		68		68																																																																															
A = Entry angle (degree)		53		46																																																																															
Q = Entry flow (pcu/hr)		750		1090																																																																															
	AM	750		1090																																																																															
	Logistic	780		900																																																																															
	PM	975		940																																																																															
Qc = Circulating flow across entry (pcu/hr)		190		25																																																																															
	AM	190		25																																																																															
	Logistic	165		25																																																																															
	PM	940		40																																																																															
<table border="1" style="width:100%; border-collapse: collapse;"> <thead> <tr> <th style="text-align: left;">Output Parameters</th> <th>Arm 1</th> <th>Arm 2</th> <th>Arm 3</th> <th>Arm 4</th> </tr> </thead> <tbody> <tr> <td>S = Sharpness of flare = $1.6*(E-V)/L$</td> <td></td> <td>0.56</td> <td></td> <td>1.60</td> </tr> <tr> <td>K = $1-0.00347*(A-30)-0.978*(1/R-0.05)$</td> <td></td> <td>0.95</td> <td></td> <td>0.98</td> </tr> <tr> <td>X2 = $V+((E-V)/(1+2*S))$</td> <td></td> <td>10.30</td> <td></td> <td>10.48</td> </tr> <tr> <td>M = $Exp((D-60)/10)$</td> <td></td> <td>2.23</td> <td></td> <td>2.23</td> </tr> <tr> <td>F = $303*X2$</td> <td></td> <td>3121</td> <td></td> <td>3174</td> </tr> <tr> <td>Td = $1+(0.5/(1+M))$</td> <td></td> <td>1.16</td> <td></td> <td>1.16</td> </tr> <tr> <td>Fc = $0.21*Td*(1+0.2*X2)$</td> <td></td> <td>0.74</td> <td></td> <td>0.75</td> </tr> <tr> <td>Qe = Capacity = $K*(F-Fc*Qc)$</td> <td></td> <td>2843</td> <td></td> <td>3093</td> </tr> <tr> <td></td> <td>AM</td> <td>2843</td> <td></td> <td>3093</td> </tr> <tr> <td></td> <td>Logistic</td> <td>2861</td> <td></td> <td>3093</td> </tr> <tr> <td></td> <td>PM</td> <td>2312</td> <td></td> <td>3082</td> </tr> <tr> <td>DFC = Entry Flow/Capacity = Q/Qe</td> <td></td> <td>0.26</td> <td></td> <td>0.35</td> </tr> <tr> <td></td> <td>AM</td> <td>0.26</td> <td></td> <td>0.35</td> </tr> <tr> <td></td> <td>Logistic</td> <td>0.27</td> <td></td> <td>0.29</td> </tr> <tr> <td></td> <td>PM</td> <td>0.42</td> <td></td> <td>0.30</td> </tr> </tbody> </table>				Output Parameters	Arm 1	Arm 2	Arm 3	Arm 4	S = Sharpness of flare = $1.6*(E-V)/L$		0.56		1.60	K = $1-0.00347*(A-30)-0.978*(1/R-0.05)$		0.95		0.98	X2 = $V+((E-V)/(1+2*S))$		10.30		10.48	M = $Exp((D-60)/10)$		2.23		2.23	F = $303*X2$		3121		3174	Td = $1+(0.5/(1+M))$		1.16		1.16	Fc = $0.21*Td*(1+0.2*X2)$		0.74		0.75	Qe = Capacity = $K*(F-Fc*Qc)$		2843		3093		AM	2843		3093		Logistic	2861		3093		PM	2312		3082	DFC = Entry Flow/Capacity = Q/Qe		0.26		0.35		AM	0.26		0.35		Logistic	0.27		0.29		PM	0.42		0.30
Output Parameters	Arm 1	Arm 2	Arm 3	Arm 4																																																																															
S = Sharpness of flare = $1.6*(E-V)/L$		0.56		1.60																																																																															
K = $1-0.00347*(A-30)-0.978*(1/R-0.05)$		0.95		0.98																																																																															
X2 = $V+((E-V)/(1+2*S))$		10.30		10.48																																																																															
M = $Exp((D-60)/10)$		2.23		2.23																																																																															
F = $303*X2$		3121		3174																																																																															
Td = $1+(0.5/(1+M))$		1.16		1.16																																																																															
Fc = $0.21*Td*(1+0.2*X2)$		0.74		0.75																																																																															
Qe = Capacity = $K*(F-Fc*Qc)$		2843		3093																																																																															
	AM	2843		3093																																																																															
	Logistic	2861		3093																																																																															
	PM	2312		3082																																																																															
DFC = Entry Flow/Capacity = Q/Qe		0.26		0.35																																																																															
	AM	0.26		0.35																																																																															
	Logistic	0.27		0.29																																																																															
	PM	0.42		0.30																																																																															
<table border="1" style="width:100%; border-collapse: collapse;"> <tr> <td style="width: 40%;">DFC of Critical Approach =</td> <td>AM</td> <td>0.35</td> </tr> <tr> <td></td> <td>Logistic</td> <td>0.29</td> </tr> <tr> <td></td> <td>PM</td> <td>0.42</td> </tr> </table>				DFC of Critical Approach =	AM	0.35		Logistic	0.29		PM	0.42																																																																							
DFC of Critical Approach =	AM	0.35																																																																																	
	Logistic	0.29																																																																																	
	PM	0.42																																																																																	
CTA Consultants Ltd.																																																																																			

Roundabout Junction Calculation

Junction : <u>(RA4) Tsing Yi Hong Wan Road / Tsing Ko Road</u>		Job No.: <u>24002HK</u>																					
Scenario : <u>2029 Design Traffic Flow</u>																							
<table border="1" style="margin: auto;"> <tr> <td colspan="4">Arm 4 Tsing Yi Hong Wan Road SB</td> </tr> <tr> <td>475</td><td></td><td>255</td><td>190</td> </tr> <tr> <td><385></td><td></td><td><240></td><td><165></td> </tr> <tr> <td>(365)</td><td></td><td>(210)</td><td>(265)</td> </tr> </table>				Arm 4 Tsing Yi Hong Wan Road SB				475		255	190	<385>		<240>	<165>	(365)		(210)	(265)				
Arm 4 Tsing Yi Hong Wan Road SB																							
475		255	190																				
<385>		<240>	<165>																				
(365)		(210)	(265)																				
<table border="1" style="margin: auto;"> <tr> <td>15</td><td><535></td><td>(550)</td><td></td> </tr> </table>				15	<535>	(550)																	
15	<535>	(550)																					
<table border="1" style="margin: auto;"> <tr> <td>330</td><td><165></td><td>(265)</td><td></td> </tr> <tr> <td>10</td><td><5></td><td>(20)</td><td></td> </tr> <tr> <td>5</td><td><385></td><td>(365)</td><td></td> </tr> </table>				330	<165>	(265)		10	<5>	(20)		5	<385>	(365)									
330	<165>	(265)																					
10	<5>	(20)																					
5	<385>	(365)																					
<table border="1" style="margin: auto;"> <tr> <td colspan="4">Arm 1 Tsing Yi Hong Wan Road</td> </tr> <tr> <td>745</td><td><1160></td><td>(1125)</td><td></td> </tr> <tr> <td></td><td></td><td></td><td></td> </tr> <tr> <td></td><td></td><td></td><td></td> </tr> <tr> <td></td><td></td><td></td><td></td> </tr> </table>				Arm 1 Tsing Yi Hong Wan Road				745	<1160>	(1125)													
Arm 1 Tsing Yi Hong Wan Road																							
745	<1160>	(1125)																					
<table border="1" style="margin: auto;"> <tr> <td colspan="4">Arm 3 Tsing Ko Road</td> </tr> <tr> <td>590</td><td><675></td><td>(695)</td><td></td> </tr> <tr> <td></td><td></td><td></td><td></td> </tr> <tr> <td></td><td></td><td></td><td></td> </tr> <tr> <td></td><td></td><td></td><td></td> </tr> </table>				Arm 3 Tsing Ko Road				590	<675>	(695)													
Arm 3 Tsing Ko Road																							
590	<675>	(695)																					
<table border="1" style="margin: auto;"> <tr> <td>25</td><td>115</td><td></td><td>0</td> </tr> <tr> <td><25></td><td><145></td><td></td><td><145></td> </tr> <tr> <td>(20)</td><td>(165)</td><td></td><td>(165)</td> </tr> </table>				25	115		0	<25>	<145>		<145>	(20)	(165)		(165)								
25	115		0																				
<25>	<145>		<145>																				
(20)	(165)		(165)																				
<table border="1" style="margin: auto;"> <tr> <td colspan="4">Arm 2 Tsing Yi Hong Wan Road NB</td> </tr> <tr> <td>480</td><td><770></td><td>(940)</td><td></td> </tr> <tr> <td></td><td></td><td></td><td></td> </tr> <tr> <td></td><td></td><td></td><td></td> </tr> <tr> <td></td><td></td><td></td><td></td> </tr> </table>				Arm 2 Tsing Yi Hong Wan Road NB				480	<770>	(940)													
Arm 2 Tsing Yi Hong Wan Road NB																							
480	<770>	(940)																					
<table border="1" style="margin: auto;"> <tr> <td>AM</td><td>[Logistic]</td><td>(PM)</td> </tr> <tr> <td>[Logistic]</td><td></td><td></td> </tr> <tr> <td>(PM)</td><td></td><td></td> </tr> </table>				AM	[Logistic]	(PM)	[Logistic]			(PM)													
AM	[Logistic]	(PM)																					
[Logistic]																							
(PM)																							
Input Parameters																							
			Arm 1	Arm 2	Arm 3	Arm 4																	
V	=	Approach half width (m)		6.7	6.3	7.6																	
E	=	Entry width (m)		13.5	12.5	15.5																	
L	=	Effective length of flare (m)		18	30	30																	
R	=	Entry radius		47	180	75																	
D	=	Inscribed circle diameter (m)		68	68	68																	
A	=	Entry angle (degree)		41	22	46																	
Q	=	Entry flow (pcu/hr)	AM	140	345	920																	
			Logistic	315	555	790																	
			PM	350	650	840																	
Qc	=	Circulating flow across entry (pcu/hr)	AM	480	590	15																	
			Logistic	770	675	535																	
			PM	940	695	550																	
Output Parameters																							
			Arm 1	Arm 2	Arm 3	Arm 4																	
S	=	Sharpness of flare = 1.6*(E-V)/L		0.60	0.33	0.42																	
K	=	1-0.00347*(A-30)-0.978*(1/R-0.05)		0.99	1.07	0.98																	
X2	=	V+((E-V)/(1+2*S))		9.78	10.03	11.89																	
M	=	Exp((D-60)/10)		2.23	2.23	2.23																	
F	=	303*X2		2963	3040	3602																	
Td	=	1+(0.5/(1+M))		1.16	1.16	1.16																	
Fc	=	0.21*Td*(1+0.2*X2)		0.72	0.73	0.82																	
Qe	=	Capacity = K*(F-Fc*Qc)	AM	2592	2795	3519																	
			Logistic	2387	2729	3101																	
			PM	2266	2713	3089																	
DFC	=	Entry Flow/Capacity = Q/Qe	AM	0.05	0.12	0.26																	
			Logistic	0.13	0.20	0.25																	
			PM	0.15	0.24	0.27																	
DFC of Critical Approach																							
	=		AM	0.26																			
			Logistic	0.25																			
			PM	0.27																			

Roundabout Junction Calculation

Junction : (RA5) Tam Kon Shan Interchange Job No.: 24002HK

Scenario : 2029 Design Traffic Flow

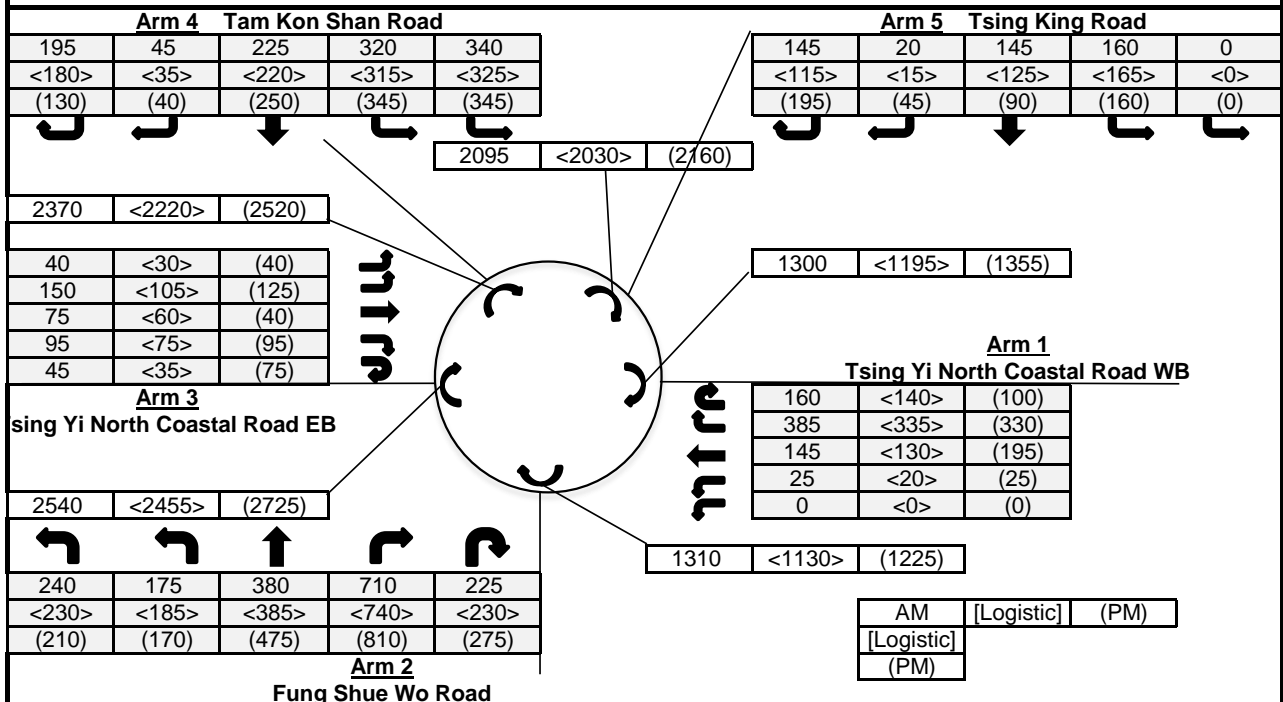

Input Parameters			Arm 1	Arm 2	Arm 3	Arm 4	Arm 5
V	=	Approach half width (m)	7	10	5.5	8	7.5
E	=	Entry width (m)	9	13.5	7.5	13.5	11
L	=	Effective length of flare (m)	9	9	11	9	10
R	=	Entry radius	100	45	45	25	45
D	=	Inscribed circle diameter (m)	115	115	115	115	115
A	=	Entry angle (degree)	30	25	25	30	45
Q	=	Entry flow (pcu/hr)					
		AM	715	1730	405	1125	470
		Logistic	625	1770	305	1075	420
		PM	650	1940	375	1110	490
Qc	=	Circulating flow across entry (pcu/hr)					
		AM	1300	1310	2540	2370	2095
		Logistic	1195	1130	2455	2220	2030
		PM	1355	1225	2725	2520	2160

Output Parameters			Arm 1	Arm 2	Arm 3	Arm 4	Arm 5
S	=	Sharpness of flare = 1.6*(E-V)/L	0.36	0.62	0.29	0.98	0.56
K	=	1-0.00347*(A-30)-0.978*(1/R-0.05)	1.04	1.04	1.04	1.01	0.98
X2	=	V+((E-V)/(1+2*S))	8.17	11.56	6.76	9.86	9.15
M	=	Exp((D-60)/10)	244.69	244.69	244.69	244.69	244.69
F	=	303*X2	2475	3503	2050	2988	2773
Td	=	1+(0.5/(1+M))	1.00	1.00	1.00	1.00	1.00
Fc	=	0.21*Td*(1+0.2*X2)	0.55	0.70	0.50	0.63	0.60
Qe	=	Capacity = K*(F-Fc*Qc)					
		AM	1823	2705	827	1520	1487
		Logistic	1884	2836	871	1615	1525
		PM	1792	2767	732	1426	1449
DFC	=	Entry Flow/Capacity = Q/Qe					
		AM	0.39	0.64	0.49	0.74	0.32
		Logistic	0.33	0.62	0.35	0.67	0.28
		PM	0.36	0.70	0.51	0.78	0.34

DFC of Critical Approach = AM 0.74
Logistic 0.67
PM 0.78

Roundabout Junction Calculation

Junction : (RA6) Tsing King Road / Fung Shue Wo Road Job No.: 24002HK

Scenario : 2029 Design Traffic Flow

1200	<1020>	(955)
------	--------	-------

15	<20>	(5)
45	<25>	(65)
500	<410>	(485)
0	<0>	(0)

25	5	600	100
<25>	<5>	<400>	<80>
(25)	(15)	(450)	(65)

0	<0>	(0)
25	<30>	(25)
80	<55>	(65)
220	<170>	(210)

395	305	115	540
<340>	<240>	<110>	<475>
(455)	(310)	(100)	(305)

135	<115>	(580)
-----	-------	-------

AM	[Logistic]	(PM)
[Logistic]		
(PM)		

Input Parameters		Arm 1	Arm 2	Arm 3	Arm 4
V	= Approach half width (m)	6.7	7.3	7.3	6.9
E	= Entry width (m)	9.7	10	9.2	8.9
L	= Effective length of flare (m)	16	20	14	16
R	= Entry radius	55	71	60	62
D	= Inscribed circle diameter (m)	112	112	112	112
A	= Entry angle (degree)	36	30	18	25
Q	= Entry flow (pcu/hr)	AM 325	1355	560	730
		Logistic 255	1165	455	510
		PM 300	1170	555	555
Qc	= Circulating flow across entry (pcu/hr)	AM 1670	135	1010	1200
		Logistic 1315	115	880	1020
		PM 1280	580	765	955

Output Parameters		Arm 1	Arm 2	Arm 3	Arm 4
S	= Sharpness of flare = 1.6*(E-V)/L	0.30	0.22	0.22	0.20
K	= 1-0.00347*(A-30)-0.978*(1/R-0.05)	1.01	1.04	1.07	1.05
X2	= V+((E-V)/(1+2*S))	8.58	9.19	8.62	8.33
M	= Exp((D-60)/10)	181.27	181.27	181.27	181.27
F	= 303*X2	2598	2783	2613	2524
Td	= 1+(0.5/(1+M))	1.00	1.00	1.00	1.00
Fc	= 0.21*Td*(1+0.2*X2)	0.57	0.60	0.57	0.56
Qe	= Capacity = K*(F-Fc*Qc)	AM 1660	2797	2185	1943
		Logistic 1865	2810	2265	2049
		PM 1886	2522	2336	2088
DFC	= Entry Flow/Capacity = Q/Qe	AM 0.20	0.48	0.26	0.38
		Logistic 0.14	0.41	0.20	0.25
		PM 0.16	0.46	0.24	0.27

DFC of Critical Approach	=	AM	0.48
		Logistic	0.41
		PM	0.46

Roundabout Junction Calculation

Junction : <u>(RA7) Tsing Yi Hong Wan Road / Tsing Sheung Road</u>		Job No.: <u>24002HK</u>																	
Scenario : <u>2029 Design Traffic Flow</u>																			
<table border="1" style="width:100%; border-collapse: collapse;"> <tr> <td colspan="2" style="text-align: center;">Arm 4</td> <td></td> <td></td> </tr> <tr> <td style="text-align: center;">75</td> <td style="text-align: center;">95</td> <td style="text-align: center;">40</td> <td></td> </tr> <tr> <td style="text-align: center;"><120></td> <td style="text-align: center;"><95></td> <td style="text-align: center;"><30></td> <td></td> </tr> <tr> <td style="text-align: center;">(115)</td> <td style="text-align: center;">(150)</td> <td style="text-align: center;">(25)</td> <td></td> </tr> </table>				Arm 4				75	95	40		<120>	<95>	<30>		(115)	(150)	(25)	
Arm 4																			
75	95	40																	
<120>	<95>	<30>																	
(115)	(150)	(25)																	
<table border="1" style="width:100%; border-collapse: collapse;"> <tr> <td style="text-align: center;">70</td> <td style="text-align: center;"><35></td> <td style="text-align: center;">(65)</td> <td></td> </tr> </table>				70	<35>	(65)													
70	<35>	(65)																	
<table border="1" style="width:100%; border-collapse: collapse;"> <tr> <td style="text-align: center;">25</td> <td style="text-align: center;"><20></td> <td style="text-align: center;">(60)</td> <td></td> </tr> <tr> <td style="text-align: center;">10</td> <td style="text-align: center;"><5></td> <td style="text-align: center;">(10)</td> <td></td> </tr> <tr> <td style="text-align: center;">0</td> <td style="text-align: center;"><5></td> <td style="text-align: center;">(10)</td> <td></td> </tr> </table>				25	<20>	(60)		10	<5>	(10)		0	<5>	(10)					
25	<20>	(60)																	
10	<5>	(10)																	
0	<5>	(10)																	
Arm 1 Tsing Sheung Road																			
<table border="1" style="width:100%; border-collapse: collapse;"> <tr> <td style="text-align: center;">175</td> <td style="text-align: center;"><220></td> <td style="text-align: center;">(280)</td> <td></td> </tr> </table>				175	<220>	(280)													
175	<220>	(280)																	
Arm 3 Tsing Yi Hong Wan Road																			
<table border="1" style="width:100%; border-collapse: collapse;"> <tr> <td style="text-align: center;">140</td> <td style="text-align: center;"><150></td> <td style="text-align: center;">(170)</td> <td></td> </tr> </table>				140	<150>	(170)													
140	<150>	(170)																	
<table border="1" style="width:100%; border-collapse: collapse;"> <tr> <td style="text-align: center;">5</td> <td style="text-align: center;">55</td> <td style="text-align: center;">5</td> <td></td> </tr> <tr> <td style="text-align: center;"><5></td> <td style="text-align: center;"><25></td> <td style="text-align: center;"><0></td> <td></td> </tr> <tr> <td style="text-align: center;">(10)</td> <td style="text-align: center;">(40)</td> <td style="text-align: center;">(5)</td> <td></td> </tr> </table>				5	55	5		<5>	<25>	<0>		(10)	(40)	(5)					
5	55	5																	
<5>	<25>	<0>																	
(10)	(40)	(5)																	
Arm 2 Tsing Sheung Road																			
<table border="1" style="width:100%; border-collapse: collapse;"> <tr> <td style="text-align: center;">75</td> <td style="text-align: center;"><125></td> <td style="text-align: center;">(275)</td> <td></td> </tr> </table>				75	<125>	(275)													
75	<125>	(275)																	
		AM	[Logistic]	(PM)															
		[Logistic]																	
		(PM)																	

<u>Input Parameters</u>		Arm 1	Arm 2	Arm 3	Arm 4
V	= Approach half width (m)		5.2	3	6.7
E	= Entry width (m)		9	8.4	12
L	= Effective length of flare (m)		25	15	23
R	= Entry radius		63	55	145
D	= Inscribed circle diameter (m)		53	53	53
A	= Entry angle (degree)		33	48	38
Q	= Entry flow (pcu/hr)		65	35	210
		AM			
		Logistic	30	30	245
		PM	55	80	290
Qc	= Circulating flow across entry (pcu/hr)		75	140	70
		AM			
		Logistic	125	150	35
		PM	275	170	65

<u>Output Parameters</u>		Arm 1	Arm 2	Arm 3	Arm 4
S	= Sharpness of flare = 1.6*(E-V)/L		0.24	0.58	0.37
K	= 1-0.00347*(A-30)-0.978*(1/R-0.05)		1.02	0.97	1.01
X2	= V+((E-V)/(1+2*S))		7.76	5.51	9.75
M	= Exp((D-60)/10)		0.50	0.50	0.50
F	= 303*X2		2350	1669	2954
Td	= 1+(0.5/(1+M))		1.33	1.33	1.33
Fc	= 0.21*Td*(1+0.2*X2)		0.71	0.59	0.83
Qe	= Capacity = K*(F-Fc*Qc)		2349	1537	2938
		AM			
		Logistic	2313	1531	2968
		PM	2203	1520	2942
DFC	= Entry Flow/Capacity = Q/Qe		0.03	0.02	0.07
		AM			
		Logistic	0.01	0.02	0.08
		PM	0.02	0.05	0.10

DFC of Critical Approach	=		AM	0.07
			Logistic	0.08
			PM	0.10

Roundabout Junction Calculation

Junction : <u>(RA8) Tsing Yi Road / Ching Hong Road</u>		Job No.: <u>24002HK</u>																													
Scenario : <u>2029 Design Traffic Flow</u>																															
<p>Arm 4 Tsing Yi Road SB</p> <table border="1" style="margin-left: auto; margin-right: auto;"> <tr><td>225</td><td>440</td><td>365</td><td></td></tr> <tr><td><145></td><td><455></td><td><265></td><td></td></tr> <tr><td>(170)</td><td>(415)</td><td>(240)</td><td></td></tr> </table>		225	440	365		<145>	<455>	<265>		(170)	(415)	(240)		<p>Arm 1</p> <table border="1" style="margin-left: auto; margin-right: auto;"> <tr><td>1160</td><td><1025></td><td>(950)</td><td></td></tr> <tr><td></td><td></td><td></td><td></td></tr> <tr><td></td><td></td><td></td><td></td></tr> <tr><td></td><td></td><td></td><td></td></tr> </table>		1160	<1025>	(950)													
225	440	365																													
<145>	<455>	<265>																													
(170)	(415)	(240)																													
1160	<1025>	(950)																													
<p>Arm 3 Ching Hong Road</p> <table border="1" style="margin-left: auto; margin-right: auto;"> <tr><td>685</td><td><495></td><td>(475)</td><td></td></tr> <tr><td>70</td><td><75></td><td>(80)</td><td></td></tr> <tr><td>60</td><td><65></td><td>(45)</td><td></td></tr> </table>		685	<495>	(475)		70	<75>	(80)		60	<65>	(45)		<p>Arm 2 Tsing Yi Road NB</p> <table border="1" style="margin-left: auto; margin-right: auto;"> <tr><td>455</td><td><415></td><td>(505)</td><td></td></tr> <tr><td>60</td><td></td><td>230</td><td>0</td></tr> <tr><td><115></td><td></td><td><250></td><td><20></td></tr> <tr><td>(115)</td><td></td><td>(335)</td><td>(0)</td></tr> </table>		455	<415>	(505)		60		230	0	<115>		<250>	<20>	(115)		(335)	(0)
685	<495>	(475)																													
70	<75>	(80)																													
60	<65>	(45)																													
455	<415>	(505)																													
60		230	0																												
<115>		<250>	<20>																												
(115)		(335)	(0)																												
		<table border="1" style="margin-left: auto; margin-right: auto;"> <tr><td>AM</td><td>[Logistic]</td><td>(PM)</td></tr> <tr><td>[Logistic]</td><td></td><td></td></tr> <tr><td>(PM)</td><td></td><td></td></tr> </table>		AM	[Logistic]	(PM)	[Logistic]			(PM)																					
AM	[Logistic]	(PM)																													
[Logistic]																															
(PM)																															
<u>Input Parameters</u>		Arm 1	Arm 2	Arm 3	Arm 4																										
V	= Approach half width (m)		6.5	7.5	8																										
E	= Entry width (m)		8.6	8.5	9																										
L	= Effective length of flare (m)		12	4	16																										
R	= Entry radius		24.5	30	28																										
D	= Inscribed circle diameter (m)		30	30	30																										
A	= Entry angle (degree)		44	40	62																										
Q	= Entry flow (pcu/hr)	AM	290	815	1030																										
		Logistic	385	635	865																										
		PM	450	600	825																										
Qc	= Circulating flow across entry (pcu/hr)	AM	725	455	360																										
		Logistic	665	415	410																										
		PM	870	505	460																										
<u>Output Parameters</u>		Arm 1	Arm 2	Arm 3	Arm 4																										
S	= Sharpness of flare = 1.6*(E-V)/L		0.28	0.40	0.10																										
K	= 1-0.00347*(A-30)-0.978*(1/R-0.05)		0.96	0.98	0.90																										
X2	= V+((E-V)/(1+2*S))		7.85	8.06	8.83																										
M	= Exp((D-60)/10)		0.05	0.05	0.05																										
F	= 303*X2		2377	2441	2677																										
Td	= 1+(0.5/(1+M))		1.48	1.48	1.48																										
Fc	= 0.21*Td*(1+0.2*X2)		0.80	0.81	0.86																										
Qe	= Capacity = K*(F-Fc*Qc)	AM	1729	2034	2138																										
		Logistic	1775	2066	2099																										
		PM	1618	1995	2060																										
DFC	= Entry Flow/Capacity = Q/Qe	AM	0.17	0.40	0.48																										
		Logistic	0.22	0.31	0.41																										
		PM	0.28	0.30	0.40																										
DFC of Critical Approach	=	AM	0.48																												
		Logistic	0.41																												
		PM	0.40																												

Roundabout Junction Calculation

Junction : <u>(RA9) Tam Kon Shan Road</u>		Job No.: <u>24002HK</u>										
Scenario : <u>2029 Design Traffic Flow</u>												
<table border="1" style="width:100%; border-collapse: collapse;"> <thead> <tr> <th>AM</th> <th>[Logistic]</th> <th>(PM)</th> </tr> </thead> <tbody> <tr> <td>[Logistic]</td> <td></td> <td></td> </tr> <tr> <td>(PM)</td> <td></td> <td></td> </tr> </tbody> </table>				AM	[Logistic]	(PM)	[Logistic]			(PM)		
AM	[Logistic]	(PM)										
[Logistic]												
(PM)												
<u>Input Parameters</u>		Arm 1	Arm 2	Arm 3	Arm 4							
V	= Approach half width (m)	3.3	4	3.4	8.5							
E	= Entry width (m)	3.9	4.9	5.8	15.1							
L	= Effective length of flare (m)	10	10	10	10							
R	= Entry radius	32	97	52	34							
D	= Inscribed circle diameter (m)	108	108	108	108							
A	= Entry angle (degree)	61	32	31	46							
Q	= Entry flow (pcu/hr)	AM 40	95	50	0							
		Logistic 45	120	60	5							
		PM 25	120	45	5							
Qc	= Circulating flow across entry (pcu/hr)	AM 5	45	85	125							
		Logistic 0	45	100	155							
		PM 5	30	95	130							
<u>Output Parameters</u>		Arm 1	Arm 2	Arm 3	Arm 4							
S	= Sharpness of flare = $1.6*(E-V)/L$	0.10	0.14	0.38	1.06							
K	= $1-0.00347*(A-30)-0.978*(1/R-0.05)$	0.91	1.03	1.03	0.96							
X2	= $V+((E-V)/(1+2*S))$	3.80	4.70	4.76	10.62							
M	= $Exp((D-60)/10)$	121.51	121.51	121.51	121.51							
F	= $303*X2$	1152	1424	1442	3218							
Td	= $1+(0.5/(1+M))$	1.00	1.00	1.00	1.00							
Fc	= $0.21*Td*(1+0.2*X2)$	0.37	0.41	0.41	0.66							
Qe	= Capacity = $K*(F-Fc*Qc)$	AM 1048	1450	1444	3025							
		Logistic 1050	1450	1438	3006							
		PM 1048	1456	1440	3022							
DFC	= Entry Flow/Capacity = Q/Qe	AM 0.04	0.07	0.03	0.00							
		Logistic 0.04	0.08	0.04	0.00							
		PM 0.02	0.08	0.03	0.00							
DFC of Critical Approach		AM	0.07									
		Logistic	0.08									
		PM	0.08									

Roundabout Junction Calculation

Junction : (RA10) Tsing Sheung Road / Tsing Ko Road Job No.: 24002HK

Scenario : 2029 Design Traffic Flow

Arm 4 Tsing Ko Road

10	205		5
<45>	<170>		<20>
(5)	(145)		(15)

Arm 1 Tsing Sheung Road WB

5	<0>	(15)
55	<60>	(90)
120	<120>	(165)

Arm 3 Tsing Sheung Road EB

330	<315>	(240)
90	<65>	(40)
25	<40>	(30)

Arm 2

70	<105>	(110)
----	-------	-------

AM [Logistic] (PM)
[Logistic] (PM)

Input Parameters		Arm 1	Arm 2	Arm 3	Arm 4
V	= Approach half width (m)	6.6		5.6	6.4
E	= Entry width (m)	12.9		16	11.6
L	= Effective length of flare (m)	18		30	30
R	= Entry radius	47		180	75
D	= Inscribed circle diameter (m)	68		68	68
A	= Entry angle (degree)	41		22	46
Q	= Entry flow (pcu/hr)	AM	180	445	220
		Logistic	180	420	235
		PM	270	310	165
Qc	= Circulating flow across entry (pcu/hr)	AM	240	70	120
		Logistic	255	105	105
		PM	180	110	85

Output Parameters		Arm 1	Arm 2	Arm 3	Arm 4
S	= Sharpness of flare = $1.6*(E-V)/L$	0.56		0.55	0.28
K	= $1-0.00347*(A-30)-0.978*(1/R-0.05)$	0.99		1.07	0.98
X2	= $V+((E-V)/(1+2*S))$	9.57		10.53	9.74
M	= $Exp((D-60)/10)$	2.23		2.23	2.23
F	= $303*X2$	2900		3191	2953
Td	= $1+(0.5/(1+M))$	1.16		1.16	1.16
Fc	= $0.21*Td*(1+0.2*X2)$	0.71		0.75	0.72
Qe	= Capacity = $K*(F-Fc*Qc)$	AM	2703	3362	2810
		Logistic	2693	3333	2821
		PM	2745	3329	2835
DFC	= Entry Flow/Capacity = Q/Qe	AM	0.07	0.13	0.08
		Logistic	0.07	0.13	0.08
		PM	0.10	0.09	0.06

DFC of Critical Approach =

AM	0.13
Logistic	0.13
PM	0.10